

CORROSION PREVENTION

We preserve values.



Fields of Application

Corrosion Prevention	5
Sealing & Insulation	6
Tank & Piers, Offshore	7

SEALID®

All-in-1 Solution	
SEALID® All-in-1 Tape	10

DENSO®

Petrolatum Tapes & Mastics

DENSO®-AQ Primer, -AQ Primer HT	14
DENSO®-Cal Primer	15
DENSO®-Jet, -Fill, -Cord Mastic	16
DENSO®-KS Mastic	17
DENSO®-KW Mastic	18
DENSO®-PF Mastic, -PF Mastic HT	19
DENSO®-Plast Mastic	20
DENSO®-Cal	21
DENSO®-Feu	22
DENSO®-Flex	23
DENSO®-Plast	24
DENSO®-Tape ET	25
DENSO®-Tape HT	26
DENSO®-Tape LT	27
DENSO®-Tape MT	28
DENSO®-Tape ST	29
DENSO®-Tec	30
DENSO®-Verte	31
DENSO®-TB System	32

VivaxCoat®

Protection Systems for Wet Surfaces

VivaxCoat®-LT	36
VivaxCoat®-MT	37
VivaxCoat®-HT	38

DENSOLEN®

PE/Butyl-Tapes & Systems

DENSOLEN®-HT, -HT25, -HT100, -MT25 Primer	42
DENSOLEN®-W, -WP, -W+ Mastic	43
DENSOLEN®-E, DENSOLEN®-N	44
DENSOLEN®-AS39 P	45
DENSOLEN®-AS40 Plus	46
DENSOLEN®-AS40 HT	47
DENSOLEN®-AS50	48
DENSOLEN®-S10	49
DENSOLEN®-AS30/-R20 MP	50
DENSOLEN®-AS39 P/-R20 HT	51
DENSOLEN®-AS40 Plus/-090	52
DENSOLEN®-AS40 Plus/-R20 HT	53
DENSOLEN®-AS40 Plus/-R25 HT	54
DENSOLEN®-AS50/-R20 HT	55
DENSOLEN®-E10/-090	56
DENSOLEN®-ET100/-R20 HT	57
DENSOLEN®-N15/-PE3	58
DENSOLEN®-N15/-PE5	59
DENSOLEN®-N60/-S20	60
DENSOLEN®-S10/-090	61
System 1 (DENSOLEN®-E12/-090/-R20 HT)	62
System 2 (DENSOLEN®-N12/-090/-R20 HT)	63
System 3 (DENSOLEN®-032-65 AS/-090/-R20 HT)	64
System 4 (DENSOLEN®-032-65 AS/-090)	65
System 5 & 6 (DENSOLEN®-032-65 AS/-R20 HT)	66

DENSIT®

Insulation & Sealing Tapes

DENSIT®-AL, -PB	70
DENSIT®-AL6	71
DENSIT®-Alltape	72
DENSIT®-Anker	73
DENSIT®-PE100	74
DENSIT®-FK, -K and -RW 120	75

PALIMEX®

Protection & Ventilation Tapes

PALIMEX®-HT Primer	78
PALIMEX®-855	79
PALIMEX®-880	80
PALIMEX®-855/-880	81
PALIMEX®-170	82
PALIMEX®-2000	83
PALIMEX®-KTB500	84

DEKOTEC®

Heat Shrinkable Sleeves

DEKOTEC®-EP Primer, -EP Primer HT	88
DEKOTEC®-DRP & -Meltstick	89
DEKOTEC®-BTS60	90
DEKOTEC®-HTS70	91
DEKOTEC®-HTS90	92
DEKOTEC®-HTS100	93
DEKOTEC®-MTS30	94
DEKOTEC®-MTS55	95
DEKOTEC®-MTS55 DI	96
DEKOTEC®-MTS55 HS65	97

DENSOLID®

Polyurethane Coatings

DENSOLID®-FK2, -FK2 C Repair Compound	106
DENSOLID®-HDD	108
DENSOLID®-HK7 C	109
DENSOLID®-TLC	110
DENSOLID®-IPL	111
DENSOMIX® Application Devices	112

MarineProtect™

Pier & Harbour Protection

MarineProtect™-Primer	116
MarineProtect™-Tape	117
MarineProtect™-100	118
MarineProtect™-2000 FD	119

DEPROTEC®

Mechanical Protection Systems

DEPROTEC®-DRM Rockshield	122
DEPROTEC®-GFK Protective Casing	125
DEPROTEC®-GFK System Corrosion Prevention	126
DEPROTEC®-PUR Protective Bandage	127

DEXPAND®

Pipe Repair System

DEXPAND®-CF 70 Composite Repair System	129
--	-----

DENSOMAT®

DENSOMAT® Wrapping Devices	131
--------------------------------------	-----

DENSO – The Company

The Success Story	132-133
Sealing Technology	135
Contact	136

STRONG BRANDS

for Enduring Protection



9 SEALID® All-in-1 Solution

SEALID® All-in-1 offers the new simplicity in pipeline construction. The universally usable tape protects for the first time worldwide against corrosive and mechanical stresses in just one work step and without additional primer.



13 DENSO® Petrolatum Tapes & Mastics

Over almost 100 years, proven corrosion prevention of complex shaped pipe components, as well as on movable or maintenance-intensive fittings, in the under and above ground area.



35 VivaxCoat® Protection Systems for Wet Surfaces

Coating system for permanent corrosion protection on wet steel pipes and fittings – ideal for applications with lines in operation.



41 DENSOLEN® PE/Butyl-Tapes & Systems

For more than 40 years, proven as permanent corrosion prevention at pipelines, welding seams and fittings for new construction and rehabilitation.



69 DENSIT® Insulation & Sealing Tapes

For decades, these universal-use tapes have successfully withstood high mechanical strains. They provide high levels of electrical insulation and are UV resistant and vibration-reducing – all of these characteristics allow for flexibility of use.



77 PALIMEX® Protection & Ventilation Tapes

PALIMEX® Protection Tapes provide permanent and robust protection for buried steel and cast iron pipelines, whether they are used individually or combined as a tape system. Even in complex ventilation systems, they provide a reliable seal for ventilation pipes.



87 DEKOTEC® Heat Shrinkable Sleeves

High quality and robust sleeves for the protection of field joints and spigot joint against corrosion and root penetration, as two- and three-layer system for normal up to high operating temperatures.



99 DENSOLID® Polyurethane Coatings

Liquid coatings for highest requirements for welding seams, soil to air interface areas and for trenchless pipe laying.



109 MarineProtect™ Pier & Harbour Protection

Corrosion and weathering protection for metal, concrete piles or wood in the splash zone of moles and harbors. Simple application above the water as well as under water.



115 DEPROTEC® Mechanical Protection Systems

Additional high resistant mechanical protection for the corrosion protection systems.



123 DEXPAND® Pipe Repair System

System solution for restoring the whole integrity of pipeline systems. Even severely weakened pipelines can be rehabilitated while pipeline is in operation.



125 DENSOMAT® Wrapping Devices

Wrapping devices for tape systems on pipes, pipe bends and welded joints.

Corrosion Prevention Tapes and Sleeves*

Produkt	Product Design		System Design			Stress Class			Temperature Range		Page
	Number of Plys	Thickness (mm)	Number of Layers		Thickness (mm)	ISO 21809-3	EN 12068 DIN 30672	GRTgaz (RV02)	min. °C (°F)	max. °C (°F)	
			Inner Tape	Outer Tape							
SEALID® All-in-1 Solution											
SEALID® All-in-1 Tape	3	1.3	2		2.6	12A-2			-50 (-58)	+90 (+194)	10
SEALID® All-in-1 Tape	3	1.3	3		3.9	12A-2	C 50		-50 (-58)	+90 (+194)	10
DENSO® Petrolatum Tapes											
DENSO®-Cal	4	1.2	2		2.4	11 A	A 30		-50 (-58)	+120 (+248)	21
DENSO®-Feu	3	1.0	2		2.0				-50 (-58)	+80 (+176)	22
DENSO®-Flex	4	1.5	2		3.0	11 A	A 50		-50 (-58)	+50 (+122)	23
DENSO®-Tape ET	3	1.1	2		2.2				-40 (-40)	+75 (+167)	24
DENSO®-Tape HT	3	2.0	2		4.0	11 A	A 100		-50 (-58)	+110 (+230)	26
DENSO®-Tape LT	3	1.9	2		2.2	11 A	A 30		-50 (-58)	+50 (+122)	27
DENSO®-Tape MT	3	1.7	2		3.4	11 A	A 60		-50 (-58)	+70 (+158)	28
DENSO®-Tape ST	3	1.15	2		2.3				-40 (-40)	+50 (+122)	29
DENSO®-Plast	4	1.1	3		3.3	11A	A 30		-50 (-58)	+50 (+122)	24
DENSO®-Tec	3	1.1	2		2.2				-40 (-40)	+50 (+122)	30
DENSO®-Verte	3	1.1	2		2.2				-50 (-58)	+50 (+122)	31
MarineProtect®-Tape	3	1.2	2		2.4				-50 (-58)	+80 (+176)	117
VivaxCoat® Protection Systems for Wet Surfaces											
VivaxCoat®-HT	3/3	2.0/1.0	2	2	6.0				-50 (-58)	+100 (+212)	36
VivaxCoat®-LT	3/3	1.9/1.1	2	2/4	6.3/8.5			HR/THR	-50 (-58)	+50 (+122)	37
VivaxCoat®-MT	3/3	1.7/1.1	2	2/3	5.9/7.0			HR/THR	-50 (-58)	+70 (+158)	38
DENSOLEN® PE-/Butyl Tapes (3-Ply) – selection –											
DENSOLEN®-E10	3	1.0	2		2.0				-50 (-58)	+70 (+158)	56
DENSOLEN®-E15	3	1.5	2		3.0				-50 (-58)	+70 (+158)	56
DENSOLEN®-N8	3	0.8	2		1.6				-50 (-58)	+70 (+158)	56
DENSOLEN®-N10	3	1.0	2		2.0				-50 (-58)	+70 (+158)	56
DENSOLEN®-N12	3	1.2	2		2.4				-50 (-58)	+70 (+158)	56
DENSOLEN®-N15	3	1.5	2		3.0				-50 (-58)	+70 (+158)	56
DENSOLEN® PE-/Butyl Tapes (Single-Tape Systems)											
DENSOLEN®-AS39 P	3	0.8	4		3.2	12A-1	C 50	HR	-50 (-58)	+85 (+185)	45
DENSOLEN®-AS40 Plus	3	0.8	3		2.4		B 50		-50 (-58)	+85 (+185)	46
DENSOLEN®-AS40 Plus	3	0.8	4		3.2	12A-1	C 50	HR	-50 (-58)	+85 (+185)	46
DENSOLEN®-AS40 HT	3	0.8	2		1.6	12A-3			-50 (-58)	+100 (+212)	47
DENSOLEN®-AS40 HT	3	0.8	4		3.2	12A-3	C 80		-50 (-58)	+100 (+212)	47
DENSOLEN®-AS50	3	1.1	2		2.2	12A-1	B 50		-50 (-58)	+85 (+185)	48
DENSOLEN®-S10	3	0.8	4		3.2		B 50		-50 (-58)	+70 (+158)	49
DENSOLEN® PE-/Butyl Tapes (Two-Tape Systems)											
DENSOLEN®-AS30/-R20 MP	3/2	0.5 / 0.5	2	2	2.0	12A-1	B 50	R	-50 (-58)	+70 (+158)	50
DENSOLEN®-AS39 P/-R20 HT	3/2	0.8 / 0.5	2	2	2.6	12A-1	C 50	HR	-50 (-58)	+85 (+185)	51
DENSOLEN®-AS40 Plus/-090	3/2	0.8 / 0.4	2	2	2.4		B 50	HR	-50 (-58)	+85 (+185)	52
DENSOLEN®-AS40 Plus/-R20 HT	3/2	0.8 / 0.5	2	2	2.6	12A-1	C 50	HR	-50 (-58)	+85 (+185)	53
DENSOLEN®-AS40 Plus/-R25 HT	3/2	0.8 / 0.65	2	2	2.9	12A-1	C 50	STHR	-50 (-58)	+85 (+185)	54
DENSOLEN®-AS50/-R20 HT	3/2	1.1 / 0.5	2	2	3.2	12A-1	C 50	THR	-50 (-58)	+85 (+185)	55
DENSOLEN®-E10/-090	3/2	1.0 / 0.4	2	2	2.8		B 30	R	-50 (-58)	+50 (+122)	56
DENSOLEN®-E100/-R20 HT	3/2	1.0 / 0.5	2	2	3.0		B 70		-50 (-58)	+100 (+212)	57
DENSOLEN®-N15/-PE3	3/2	1.5 / 0.4	2	1	3.4		B 30	HR	-50 (-58)	+70 (+158)	58
DENSOLEN®-N15/-PE5	3/2	1.5 / 0.5	2	2	4.0		C 30	HR	-50 (-58)	+70 (+158)	59
DENSOLEN®-N60/-S20	3/3	1.2 / 0.5	2	2	3.4	12A-1	C 50	HR	-50 (-58)	+70 (+158)	60
DENSOLEN®-S10/-090	3/2	0.8 / 0.4	2	2	2.4			HR	-50 (-58)	+70 (+158)	61
DENSOLEN® PE-/Butyl Tapes (Multi-Tape Systems)											
System 1 (DENSOLEN®-E12/-090/-R20 HT)	3/2/2	1.2/0.4/0.5	2	2+2	4.2		C 30	THR	-50 (-58)	+70 (+158)	62
System 2 (DENSOLEN®-N12/-090/-R20 HT)	3/2/2	1.2/0.4/0.5	2	2+2	4.2		C 50	THR	-50 (-58)	+70 (+158)	63
System 3 (DENSOLEN®-032-65 AS/-090/-R20 HT)	3/2/2	0.65/0.4/0.5	2	2+2	3.1		C 50	THR	-50 (-58)	+70 (+158)	64
System 4 (DENSOLEN®-032-65 AS/-090)	3/2	0.65/0.4	5	2	4.1		C 50	THR	-50 (-58)	+70 (+158)	65
System 5 (DENSOLEN®-032-65 AS/-R20 HT)	3/2	0.65/0.5	2	2	2.3		B 50		-50 (-58)	+70 (+158)	66
System 6 (DENSOLEN®-032-65 AS/-R20 HT)	3/2	0.65/0.5	2	3	2.8		C 50	THR	-50 (-58)	+70 (+158)	66
DEKOTEC® Heat Shrinkable Sleeves											
DEKOTEC®-BTS60	2	2.6**			2.6**	14A-2	C 60		-40 (-40)	+70 (+158)	90
DEKOTEC®-HTS70	3	1.8-2.8**			1.8-2.8**	14B-1	C 60	THR	-40 (-40)	+80 (+176)	91
DEKOTEC®-HTS90	3	1.8-2.8**			1.8-2.8**		C 80	THR	-40 (-40)	+100 (+212)	92
DEKOTEC®-HTS100	3	2.6**			2.6**	14B-2	C 100		-40 (-40)	+120 (+248)	93
DEKOTEC®-MTS30	2	1.8-2.6**			1.8-2.6**	14A-1	C 30	HR	-35 (-31)	+40 (+104)	94
DEKOTEC®-MTS55	2	1.8-2.6**			1.8-2.6**	14A-1	C 50	HR	-35 (-31)	+70 (+158)	95
DEKOTEC®-MTS55 DI	2	1.8-2.5**			1.8-2.5**	14A-1	C 50		-35 (-31)	+70 (+158)	96
DEKOTEC®-MTS55 HS65	2	1.9**			1.9**	14A-2	C 50		-35 (-31)	+70 (+158)	97

Liquid Coatings*

Produkt	Product Design		Specialties	Stress Class			Temperature Range		Page
	Number of Plys	Thickness (mm)		ISO 21809-3	EN 10290	GRTgaz (RV02)	min. °C (°F)	max. °C (°F)	
DENSOLID® Polyurethan Coatings									
DENSOLID®-FK2	1	> 1.5	ideal for factory and field-joint coating and soil to air interface areas	18B	B, Typ 3	HR & THR	-40 (-40)	+80 (+176)	106
DENSOLID®-FK2 C	1	> 1.5		18B	B, Typ 3	HR & THR	-40 (-40)	+80 (+176)	106
DENSOLID®-HDD	1	> 2.5	ideal for horizontal directional drilling (HDD)	18B	B, Typ 3		-40 (-40)	+80 (+176)	108
DENSOLID®-TLC	1	> 2.5	ideal for pipe driving/pipe ramming processes	B, Typ 3			-40 (-40)	+80 (+176)	110

*The overview shows a selection of the extensive product range without promising any product features.

The respective product properties can be found in the specific product data sheet, which can be found in the most current version at denso-group.com.

**Corresponds to the thickness of the Heat Shrinkable Sleeve at point of delivery.

CORROSION PREVENTION

Pipe Storage

- SEALID® All-in-1 Solution S. 9
- DENSOLEN® PE/Butyl Tapes S. 41
- DENSOLID® Polyurethane Coatings S.105
- VivaxCoat® Protection System S. 35

Soil to Air Interface Area

- DENSOLID® Polyurethane Coatings S.106
- DEPROTEC® GRP-Systems S.121

Trenchless Installation

- DENSOLID® Polyurethane Coatings S.105
- DEPROTEC® GRP-Systems S.121

Pipeline Repair

- SEALID® All-in-1 Solution S. 9
- DENSOLEN® PE/Butyl Tapes S. 41
- DENSOLID® Polyurethane Coatings S.105
- DENSOMAT® Wrapping Devices S.131
- DEXPAND® Pipe Repair System S.129
- VivaxCoat® Protection System S. 35

Field-Joint Coating

- SEALID® All-in-1 Solution S. 9
- DENSO® Petrolatum Tapes S. 13
- DEKOTEC® Heat Shrinkable Sleeves S. 88
- DENSOLEN® PE/Butyl Tapes S. 41
- DENSOLID® Polyurethane Coatings S.105
- DENSOMAT® Wrapping Devices S.131
- VivaxCoat® Protection System S. 35

Station Construction

- SEALID® All-in-1 Solution S. 9
- DEKOTEC® Heat Shrinkable Sleeves S. 87
- DENSO® Petrolatum Tapes S. 13
- DENSOLASTIC® Polyurethan Sealings* S. 41
- DENSOLEN® PE/Butyl Tapes S.105
- DENSOLID® Polyurethane Coatings S.105
- DENSOMAT® Wrapping Devices S.131
- VivaxCoat® Protection System S. 35

SEALING & INSULATION

Climate & Ventilation Construction

- DENSIT® Sealing Tapes S. 69
- GOMEX® Profiles* S. 77
- PALIMEX® Ventilation Tapes S. 77



Pipes

- SEALID® All-in-1 Solution S. 9
- DENSIT® Insulation Tapes S. 69
- DENSO® Petrolatum Tapes S. 13
- DENSOLEN® PE/Butyl Tapes S. 41
- DENSOLID® Polyurethane Coatings S. 105
- GOMEX® Profiles* S. 77
- PALIMEX® Protection Tapes S. 77

Carriage Construction

- DENSIT® Insulation Tapes S. 69

Cable & Pipe Entry Points

- SEALID® All-in-1 Solution S. 9
- DENSO® Petrolatum Tapes S. 13
- DENSOLEN® PE/Butyl Tapes S. 41
- GOMEX® Profiles* S. 77

TANK & PIERS, OFFSHORE

Offshore

- DENSO® Petrolatum Tapes S. 13
- DENSOLEN® PE/Butyl Tapes S. 41
- MarineProtect™ Jetty Pile Protection S.115
- VivaxCoat® Protection System S. 35

Tank Farm

- DENSO®-TB System S. 32

Pier Installations

- DENSOLASTIC® Bollards Protection* S.115
- MarineProtect™ Jetty Pile Protection S. 35
- VivaxCoat® Protection System S. 35



SEALID®

All-in-1 Solution

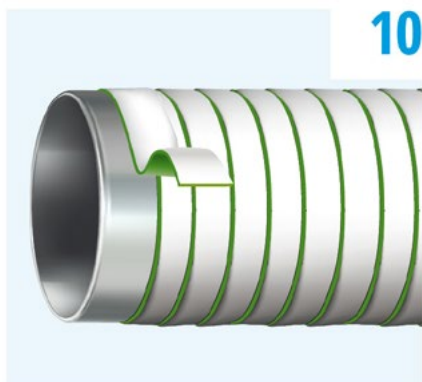

SEALID® All-in-1 Tape

SEALID® All-in-1 offers simultaneous prevention against corrosion and mechanical stress – with just one product in just one wrapping process. Without time-consuming and cost-intensive primer.

Whether whole pipe wrapping during rehabilitation, weld seam protection in new construction or protection of complicated shaped components – SEALID® All-in-1 is the solution for many applications.

The primerless tape meets the requirements of ISO 218093 up to +70°C and EN 12068 up to stress class C50 in only one wrapping process .

SEALID®-Tape

Primer-free all-in-one solution for permanent corrosion prevention of steel pipes and pipelines at operating temperatures up to +70°C (+158°F).

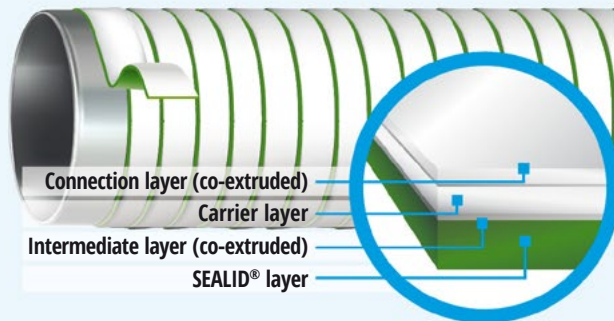

For temperatures from -50°C (-58°F) to +90°C (+194°F).



Corrosion and mechanical protection in a single product with just one wrapping process.



Primer-free, solvent-free and environmentally friendly.



Fulfills the requirements of ISO 21809-3 Type 12A-2 at +70°C (+158°F), with just a 2-ply application (in a single wrapping process).



Fulfills the requirements of EN 12068-C 50 and DIN 30672-C 50 in a single wrapping process.

SEALID®-Tape is a patented global innovation.

Secure corrosion prevention and also long-term protection against mechanical loads are ensured with one single product without primer, extensive surface preparation or additional application tools.

SEALID®-Tape fulfils the world's leading standards and differs from all existing solutions.

The resulting benefits are significant:

1. Cost saving due to faster work speed with a reduced number of work steps.
 - a. No primer, b. No (air-)drying, c. One single wrapping process
2. Cost saving because of the ease of transport, storage and application as no hazardous substance requirement needs to be met.
3. Elimination of risks to health and environmental as the product is solvent-free.

SEALID®-Tape has outstanding surface wetting characteristics. The two layers of the spiral-wrapped tape **quickly fuse together** and form a closed and **durable protective hose**. The system is impermeable for water vapour and oxygen and it is resistant against soil bacteria and soil electrolytes.

The product is also distinguished by exceptional properties such as minimised cathodic disbondment together with an extremely high peel and lap shear strength.

SEALID® tape is manufactured using real multi-layer coextrusion. When spirally wrapped on the pipe, the SEALID® coating amalgamates with the connection layer to form a continuously closed hose-type coating of outstanding durability and resistance.

A single wrapping process (50% overlap) is enough to fulfil the requirements of **ISO 21809-3** at operating temperatures of up to **+70°C (+158°F)**. The requirements of **EN 12068** and **DIN 30672** for class C50 are also met with a single wrapping process (67% overlap).

The product can easily be applied by hand or using modern wrapping devices.

SEALID®-Tape is compatible with PE, PP, FBE, PU and bitumen factory coatings.

Further information:



Typical product properties (Excerpt*)

Property	Unit	Typical value	Test method
Outside colour	-	white	-
Inside colour	-	green	-
Total thickness	mm	≥ 1.30	
Outside adhesive layer thickness	mm	≥ 0.08	ISO 4591
Carrier film thickness	mm	≥ 0.38	ASTM D1000
Inside adhesive layer thickness	mm	≥ 0.84	
Elongation at break	%	600	
Tear resistance	(+23°C/+73°F) N/cm	140	EN 12068
Electrical insulation resistance	Ω m ²	≥ 10 ¹⁰	
Dielectric strength	kV / mm	≥ 40	DIN 53481
Operating temperature	°C (°F)	-40 to +70 (-40 to +158)	

Property	Test temperature	Unit	Typical value		Test method
			2-ply	3-ply	
Impact resistance	+23°C (+73°F)	J/mm	≥ 4.0	≥ 5.0	
Indentation resistance (residual layer thickness)	+70°C (+158°F)	mm	≥ 0.65	≥ 1.0	
Cathodic disbondment resistance	+23°C (+73°F)	mm	≤ 10		
Peel strength (inner layer/outer layer)	+23°C (+73°F)	N/cm	≥ 30		ISO 21809-3
Peel strength (steel surface)	+23°C (+73°F)	N/cm	≥ 15		
Lap shear strength	+23°C (+73°F)	N/cm ²	≥ 8		
	+70°C (+158°F)		≥ 3		

* For further product information as well as details on ordering and packaging, please refer to the product data sheet at denso-group.com.



Get ready for the impossible.

SEALID® All-in-1

Corrosive plus mechanical protection in just one step. Without any primer. Only **SEALID® All-in-1** makes it possible. Patented safety fulfilling ISO 21809-3 and EN 12068. Saving time and money couldn't be more simple. [sealid.de](https://www.sealid.de)



SEALID® All-in-1 Wrap once. All done.



DENSO®

Petrolatum Tapes & Mastics



DENSO® Petrolatum -Mastics

DENSO® Petrolatum Mastics moisten all metal surfaces optimally and fill the cavities in metallic structures. Together with DENSO® Petrolatum Tapes they guarantee a permanent corrosion prevention.



DENSO® Petrolatum -Tapes

Based on the experience of more than 90 years, DENSO® Petrolatum Tapes meet the highest quality standards. They distinguish themselves through their permanent plastic properties, flexibility and optimal moisturizing of surfaces.

DENSO®-AQ Primer, -AQ Primer HT

Petrolatum-based corrosion prevention mastic for coating moist metallic surfaces with operating temperatures of up to +100°C (+212°F).



For operating temperatures up to +100°C (+212°F).



Outstanding moistening of wet surfaces.



Rust removal with a wire brush is adequate as the surface pretreatment.



No pipe interruption during rehabilitation of pipes in operation.



Solvent-free.

DENSO®-AQ Primer, -AQ Primer HT is a petrolatum-based corrosion prevention mastic. More than 100 years of experience, especially with the petrolatum tapes (DENSO® Tape) invented by DENSO, have been utilised for the development of the tape and guarantee the highest quality.

Both Primer were specially developed to **coat moist pipelines and components**. Such moist surfaces can be found, for example, on pipelines that are under strain or in areas where air humidity is high. In such conditions, the usual corrosion prevention coatings cannot be used.

By using DENSO®-AQ Primer, DENSO®-AQ Primer HT, you can save costs on **pipeline interruptions** and you can avoid long waiting times for renovation measures.

Use both Primer together with tried and tested **DENSO® Petrolatum tapes**. There are various different tape types depending on the load category and operating temperature.

These Primer are component of the corrosion protection system **VivaxCoat®**, which consists of the corrosion prevention tape **DENSO®-Tape LT, DENSO®-Tape MT** or **DENSO®-Tape HT** and the mechanical protection tape **DENSOLEN®-AS50** or **DENSOLEN®-ET100**. The **VivaxCoat®-HT** system fulfils the requirements of EN12068 Class A100 and ISO21809-3 Type 11A.

Simply apply DENSO® AQ Primer HT by hand or using a spatula on a surface from which any rust or loose adhesions have been removed. On moist substrates, moisture is displaced from the surface and the surface is protected against corrosive media.

Typical product properties (Excerpt*)

Property	Unit	Typical value		Test method
		DENSO®-AQ Primer	DENSO®-AQ Primer HT	
Primer Paste				
Processing temperature	°C (°F)	-10 to +50 (+14 to +122)	+5 to +50 (+41 to +122)	-
Operating temperature	°C (°F)	-30 to +80 (-22 to +176)	-40 to +100 (-40 to +212)	-
Dripping point DENSO®-AQ Primer HT	°C (°F)	>+100 (>+212)	>+120 (>+248)	DIN 51801
Cathodic disbondment resistance 28 days, +23 °C (+73°F) ⁽¹⁾	mm (Radius)	≤ 7 (with DENSO®-Tape MT)	≤ 9 (with DENSO®-Tape HT)	EN 12068
Thermal aging 100d at +120°C (+248°F) ⁽¹⁾	-	Cohesive separation pattern (with DENSO®-Tape MT)	Cohesive separation pattern (with DENSO®-Tape HT)	EN 12068

⁽¹⁾with DENSO®-Tape HT

* For further product information as well as details on ordering and packaging, please refer to the product data sheet at denso-group.com.

DENSO®-Cal Primer

Corrosion prevention mastic on petrolatum basis for the coating of pipelines with operating temperatures up to +110°C (+230°F).

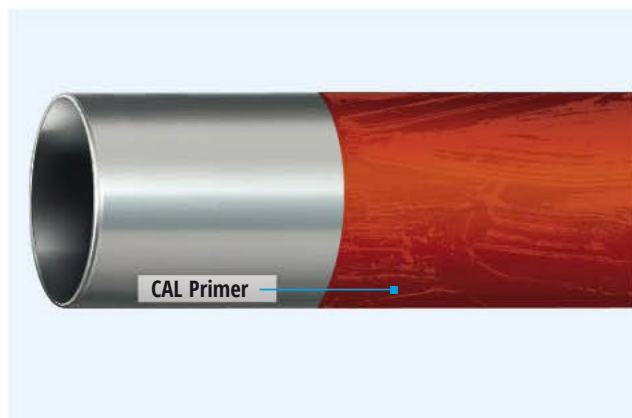

For temperatures from -50°C (-58°F) bis +110°C (+230°F).



Solvent-free.



No preheating of the surface required.



High plasticity.



Excellent surface-coating properties.

DENSO®-Cal Primer is a petrolatum-based corrosion prevention mastic. It is used as a primer prior to the application of **DENSO®-Cal tape** to increase adhesion at low application temperatures.

As the corrosion prevention system needs requires a low temperature for application, but the pipelines to which it is applied reach high temperatures during operation, the installation of corrosion protection can prove challenging.

Thanks to special modifications and a high-performance additive, DENSO®-Cal primer is stable for use at high **operating temperatures of up to +110°C (+230°F)**.

When using **DENSO®-Cal Primer**, there is **no need to preheat** the substrate – even at low temperatures – to achieve good adhesion to the DENSO®-Cal tape.

The DENSO®-Cal Primer is **easy to apply by hand**. The product is free from solvents for **maximum environmental compatibility**.

Typical product properties (Excerpt*)

Properties	Unit	Typical value	Test method
Processing temperature	°C (°F)	-10 to +50 (+14 to +122)	-
Operating temperature	°C (°F)	-40 to +110 (-40 to +230)	-
Color	-	red	-

* For further product information as well as details on ordering and packaging, please refer to the product data sheet at denso-group.com.

DENSO®-Jet, -Fill, -Cord

Permanent plastic corrosion prevention mastic on petrolatum basis for the molten pressure injection in prestressed anchor systems, prestressed braids and flange connections.

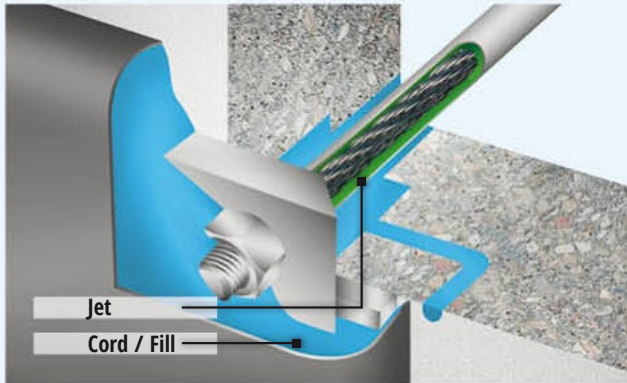

For operating temperatures up to +65°C (+149°F).



Ideal for prestressed anchors, prestressed braids and flange connections.



Low shrinking during cooling.



Very good moistening of steel surfaces.



High adhesion.

DENSO®-Jet, **DENSO®-Fill** and **DENSO®-Cord** are permanent plastic, meltable corrosion prevention mastics on petrolatum basis for the use in prestressed anchor systems, prestressed braids and between the flange plates. **DENSO®-Jet** and **DENSO®-Fill** are designed especially for molten pressure injections into cavities at prestressed anchor systems, DENSO®-Fill moreover for the gap at flange connections. They differentiate itself with respect to their temperature stability of +40°C (+104°F) for DENSO®-Jet and up to +65°C (+149°F) for DENSO®-Fill.

Both mastics can be injected by a machine (molten) or through cartridges (slightly heated). DENSO®-Jet and DENSO®-Fill are available in practical package sizes matching any construction measure.

DENSO®-Cord has a very low melt viscosity (temperature dependent) and therefore it is **ideally suited for long flow paths**, e.g. of **up to 50 m** and small gaps and cavities that must be filled. Therefore, DENSO®-Cord will be processed for the filling of individual prestressed braids by using special equipment.

Usage DENSO®-Jet

- Pressure injection into long, narrow cavities at prestressed anchors, e.g. into the annular gap between duct and prestressed steel in the area of the free steel length.
- Filling of the core of prestressed bundles by using special equipment.
- Filling the cavities in the area of the anchor head at permanent temperature stresses up to +40°C (+104°F).

Usage DENSO®-Fill

- Filling the cavities in the area of the anchor head at permanent temperature stresses +65°C (+149°F).
- Filling of the annular space between prestressed anchor and fire protection duct in structural design and bridge construction.
- Coating of steel protrusions exposed to the air.
- Molten filling of horizontal and vertical gaps at flange connections.

Usage DENSO®-Cord

- Molten filling of individually encased prestressed braids by using special equipment.

Typical product properties (Excerpt*)

Properties	Unit	Typical properties			Test method
		DENSO®-Jet	DENSO®-Fill	DENSO®-Cord	
Color	-	dark brown	brown	dark brown	-
Saponification number	mg(KOH)/g	1.0	1.0	1.0	DIN EN 12068
Operating temperature	°C (°F)	≤+40 (+104)	≤+65 (+149)	≤+40 (+104)	
Processing temperature	Machine injection	+90 - +120 (+194 - +248)	+90 - +120 (+194 - +248)	+90 - +120 (+194 - +248)	
	Cartridge injection	+40 - +85 (+104 - +185)	+40 - +85 (+104 - +185)	-	
Density (+23°C/+73°F)	g/cm ³	0.94	0.92	0.89	ISO 2811
thermal Contraction coefficient +100°C to +23°C (+212°F to +73°F)	grd ⁻¹	0.61 *10 ⁻³	0.77 *10 ⁻³	0.94 *10 ⁻³	ISO 2811
Dripping point according to Ubbelohde	°C (°F)	68	83	66	DIN 51801
Viscosity (Rotational viscometer)	(+55°C/+131°F)	-	4000	500	
	(+65°C/+149°F)	2000	1000	150	DIN 53019-1
	(+85°C/+185°F)	450	350	50	
Water absorption (+23°C/+73°F)	1 day	< 0.01	< 0.01	< 0.01	DIN EN ISO 62
	23 days	0.08	0.08	0.12	
Specific electrical resistivity	Ω *cm	> 10 ⁹	> 10 ⁹	> 10 ⁹	DIN IEC 60093

* For further product information as well as details on ordering and packaging, please refer to the product data sheet at denso-group.com.

DENSO®-KS

Meltable corrosion prevention mastic on petrolatum basis for the filling of sleeve pipes at installation sets.



For temperatures from -40°C (-40°F) to +50°C (+122°F).



Prevents voltage drops at linkages of installation sets.



Slide rods remain switchable even at low temperatures.



Permits the holiday detection in active corrosion protection.



Solvent-free.

DENSO®-KS is a permanent plastic corrosion prevention mastic on petrolatum basis for the molten filling of sleeve pipes.

Contaminations collect often in sleeve pipes of ground installation armatures, which can result in a standing water column in the sleeve pipe.

At cathodic protected pipelines voltage drops may develop in the local protection potential, which can reach values of several 100 mV. Such defects require on one hand an increased protective current and on the other hand defects in close proximity cannot be detected or with difficulties only due to the overlapping signals.

These problems can be solved effectively and cost-efficient with DENSO®-KS. DENSO®-KS can be fused with simple tools (e.g. with the **DENSO®-Meltomat**),

which means that the previously cleaned sleeve pipes can be filled. The processing takes place at relatively low temperatures of +70°C to +90°C (+158°F to +194°F), which means that high powered boilers are not required and that the thermal shrinkages is limited.

The mastic remains permanent plastic after the solidifying, which means that the linkage can be actuated even at low temperatures.

The head of the linkage will not be filled completely to maintain this good accessibility and an encasement with, for example, **DENSO®** petrolatum tape (e.g. **DENSO®-Tec** or **DENSO®-Plast**) can take place.

Typical product properties (Excerpt*)

Properties	Unit	Typical value	Test method
Color	-	red	-
Saponification number	mg KOH / g	≤ 2	DIN EN 12068
Operating temperature	°C (°F)	≤ +50 (+122)	-
Processing temperature	°C (°F)	+70 to +90 (+158 to +194)	-
Breakaway torque (linkage with 25 mm edge length)	Nm / (20cm) (-10°C/+14°F)	25	-

* For further product information as well as details on ordering and packaging, please refer to the product data sheet at denso-group.com.

DENSO®-KW Mastic

Permanently plastic, petrolatum-based trowelable corrosion protection mastic.



For temperatures from -100°C (-148°F) to +60°C (+140°F).



Superior, long-lasting protection against corrosion.



Suitable for refrigeration pipelines and plant.



Permanently elastic even at low temperatures.

DENSO®-KW is a permanently plastic, petrolatum-based corrosion protection mastic.

DENSO®-KW is optimized for **corrosion prevention on cooling pipes and pipeline parts**. As one example, DENSO®-KW can be applied to half-shells or plates that are then attached as thermal insulation to refrigeration lines. Once coated, these half-shells can then be applied to the pipelines.

Thanks to the excellent stability exhibited by DENSO®-KW, no additional fixing materials are required.

DENSO®-KW **reliably wets the pipe-surface while sealing the surface against moisture**.

Once applied, half-shells can be wrapped with a **DENSOLEN®** 2-layer tape (e.g. **DENSOLEN®-PE3**) and so fixed in place.

Thanks to the permanently elastic qualities of DENSO®-KW, insulation and coverings can be easily removed, ensuring that plant components remain easily accessible.

Typical product properties (Excerpt*)

Properties		Unit	Typical value
Color		-	white, cream-colored
Operating temperature		°C (°F)	-100 to +30 (-148 to +86)
	Environment	°C (°F)	-10 to +50 (+14 to +122)
Working temperature	Pipe surface	°C (°F)	-10 to +30 (+14 to +86)
	Mastic	°C (°F)	-10 to +30 (+14 to +86)
Density		g/cm ³	1.26 (app.)

* For further product information as well as details on ordering and packaging, please refer to the product data sheet at denso-group.com.

DENSO®-PF Mastic, -PF Mastic HT

Hydrophobic styrofoam ball-containing petrolatum-based mastic filler for filling cavities and smoothing uneven surfaces for subsequent coverage with a DENSO® petrolatum tape.

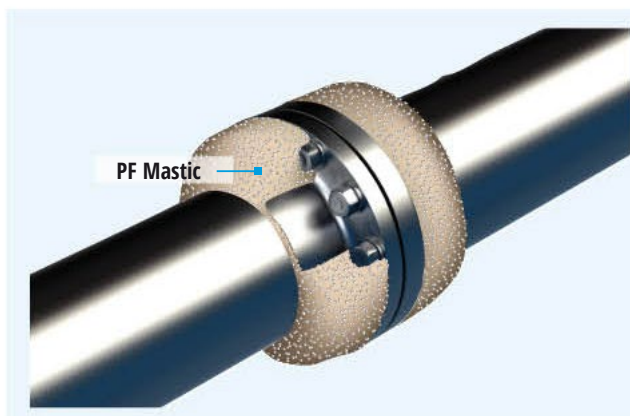

For temperatures from -40°C (-40°F) to +50°C (+122°F).



Easiest manual application.



Solvent-free.



Cold application.

DENSO®-PF Mastic is a hydrophobic petrolatum-based mastic filler for filling cavities and smoothing uneven surfaces on buried pipeline components (e.g. flanges and fittings). Thanks to its styrofoam ball content, DENSO®-PF Mastic is **easier to apply at low temperatures** than traditional petrolatum mastic fillers.

DENSO®-PF Mastic offers **outstanding formability** and permits the easy filling of cavities such as gaps between flange plates. This reliably prevents cavities and forms a complete corrosion prevention coating.

The low density makes transport easier and permits outstanding stability even on the bottom of the pipe.

DENSO®-PF Mastic is applied by hand or using a spatula to the surface to be coated. This application process moulds the mastic so that when **DENSO®** petrolatum tape is applied, it covers the entire surface of the coated area, without any gaps in contact.

DENSO®-PF Mastic HT is a product variant that is **exceptionally easy to apply even at higher ambient temperatures**, and is **resistant to temperatures up to +50°C (+122°F)**.

DENSO®-PF Mastic and DENSO®-PF Mastic HT are compatible with all DENSO® petrolatum tapes. A product such as DEPROTEC®-DRM PP 500 Plus rockshield can be used to provide additional mechanical protection.

Typical product properties (Excerpt*)

Properties	Unit	Typical value		Standard
		DENSO®-PF Mastic	DENSO®-PF Mastic HT	
Color	-	brown	green-grey	-
Saponification number	mg (KOH)/ g	≤ 2	≤ 2	DIN EN 12068
Operating temperature	°C (°F)	-40 to +30 (-40 to +86)	-40 to +50 (-40 to +122)	-
Processing temperature	°C (°F)	0 to +30 (+32 to +86)	0 to +50 (+32 to +122)	-
Density	g/cm ³	0.5 - 0.55	0.5 - 0.55	ISO 2811
Dripping point (Ubbelohde)	°C (°F)	≥ +65 (≥ +149)	-	DIN 51801
Cone penetration	1/10 mm	85	60	DIN 51804

* For further product information as well as details on ordering and packaging, please refer to the product data sheet at denso-group.com.

DENSO®-Plast Mastic

Hydrophobic mastic filler on petrolatum basis for the filling of cavities and the equalization of uneven surfaces.

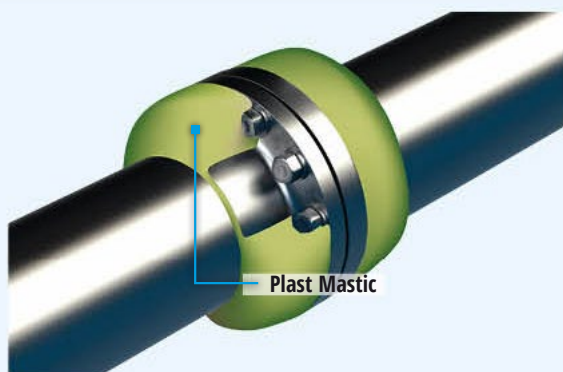

- ✓ Ideal for the filling of cavities and for the surface equalization.
- ✓ Very good moldability and modeling properties.
- ✋ Simple manual processing.
- ✓ Durable corrosion prevention through petrolatum.
- ✓ Compatibel with all DENSO® petrolatum tapes.

DENSO®-Plast Mastic is a hydrophobic mastic filler on petrolatum basis for the **filling of cavities** as well as the **equalization of uneven surfaces** at buried pipeline components (e.g. flanges and armatures). DENSO®-Plast Mastic, due to its reinforcement with filler materials and fibers, permits a **good moldability and stability**.

DENSO®-Plast Mastic will be applied manually or with a palette-knife to the surface to be coated. For this purpose the mastic will be modeled in such a way that **DENSO®** petrolatum tape can wrap completely seated across the coated area.

DENSO®-Plast Mastic is compatible with all DENSO® petrolatum tapes, such as the corrosion prevention tape **DENSO®-Plast**.

A **DEPROTEC®-DRM PP** rockshield made from robust Polypropylene nonwoven can be used as an additional mechanical protection.

Typical product properties (Excerpt*)

Properties	Unit	Typical value	Test method
Color	-	green-grey	-
Saponification number	mg(KOH)/ g	≤ 2	DIN EN 12068
Operating temperature	°C (°F)	to +50 (+122)	-
Processing temperature	°C (°F)	+4 to +30 (+39 to +86)	-
Structure	(+4°C/+39°F)	Plastic, still formable, not brittle	-
	(+23°C/+73°F)	Plastic, easily formable	-

* For further product information as well as details on ordering and packaging, please refer to the product data sheet at denso-group.com.

DENSO®-Cal

Cold applied corrosion prevention tape for mechanically unstressed pipelines and pipeline components at operating temperatures up to +110°C (+230°F).

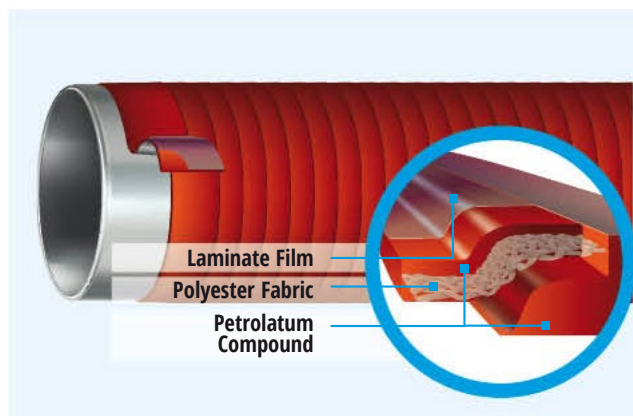

For temperatures from -50°C (-58°F) to +120°C (+248°F).



High plasticity and flexibility.



Electrically insulating and diffusion resistant.



No preheating of the surface required.

DENSO®-Cal is a corrosion prevention tape that can be processed cold on the basis of polymer modified petrolatum.

DENSO®-Cal consist of an impregnated polyester fabric, which is coated on both sides with a corrosion prevention petrolatum mastic. The petrolatum mastic is stabilized by polymer additives and therefore permits **operating temperatures of up to +110°C (+230°F)**.

DENSO®-Cal has a **peel strength**, which is exceptional for petrolatum tapes, **even for higher temperatures**, and provides a **good flexibility**. In addition DENSO®-Cal provides a **single side laminated PP film**, which prevents a washing out of the protective mass, e.g. caused by rising or falling groundwater. DENSO®-Cal will be wrapped in spirals with the film side to the outside and with at least 50% overlapping around the pipe.

DENSO®-Cal is ideally suited for the encasing of pipelines and a pipeline armatures, which carry hot media and which are located in warm environments.

DENSO®-Cal can also be applied to surfaces that are not preheated. For surface temperatures of less than (+50°C/+122°F), a coating of the surface takes place initially with the **DENSO®-Cal Primer**, a petrolatum mastic that can be processed easily by hand, which achieves a fast and complete coverage of the surface and a good adhesive connection to the DENSO®-Cal tape.

A rockshield **DEPROTEC®-DRM PP** or the polyurethane glass fiber fabric **DEPROTEC®-PUR** can be applied across the encasement to achieve an increased mechanical protection.

Typical product properties (Excerpt*)

Properties	Unit	Typical value	Test method
Thickness	mm	≥ 1.2	-
Specific electrical insulation resistance	Ω m²	≥ 10 ⁶	EN 12068
Dripping point	°C (°F)	≥ 130 (≥ 266)	DIN ISO 2176
Color	-	red	-
Carrier	-	Polyester fabric	-
Thickness PP laminate film	µm	40	-
Elongation at break	%	≥ 15	-
Operating temperature	°C (°F)	+40 to +110 (+104 to 230)	-
Processing temperature	Tape	°C (°F)	+5 to +50 (+41 to +122)
	Pipe surface	°C (°F)	+40 to +110 (+104 to 230)
	Pipe surface (with primer)	°C (°F)	-10 to +50 (+14 to +122)

* For further product information as well as details on ordering and packaging, please refer to the product data sheet at denso-group.com.

DENSO®-Feu

Petrolatum tape for sealing and for corrosion prevention at metallic components, pipes and armatures with operating temperatures up to +70°C (+158°F).

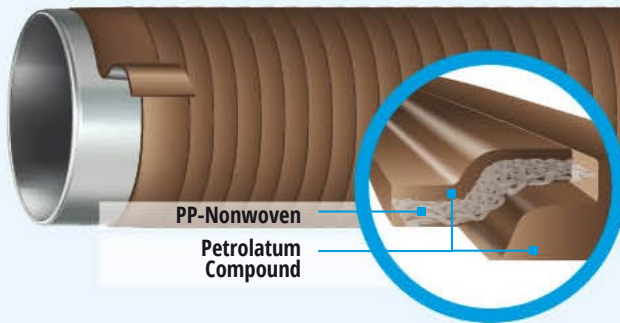

For temperatures from -50°C (-58°F) to +80°C (+176°F).



High plasticity and flexibility.



No preheating of the surface required.



Simple manual processing.

DENSO®-Feu is a cold processable corrosion prevention tape on the basis of petrolatum.

DENSO®-Feu consists of an impregnated polypropylene nonwoven carrier, which is coated on both sides with a corrosion prevention petrolatum mastic. The petrolatum mastic is stabilized by polymer additives, which means that DENSO®-Feu can be used at **operating temperatures of -40°C (-40°F) to +70°C (+158°F)**.

DENSO®-Feu can be applied **without heating the surface** and it **moistens the surface even at low temperatures**. DENSO®-Feu is based on more than 90 years of experience of the DENSO Group Germany in the production of high quality corrosion prevention products on petrolatum basis. DENSO®-Feu is basically impermeable against water and oxygen and it is electrically insulating. Based on its exceptional properties combination, DENSO® Feu is used in many applications.

- Corrosion prevention for pipelines, pipeline components, pipe connections and armatures.
- Corrosion prevention for constructional metallic components.
- Corrosion prevention of metal parts or pipe systems inserted into concrete or screed.
- Galvanic separation layer for metallic constructions.
- Sealing of thermally insulated metal sheet encasements at cold or heat carrying pipelines and components.
- Sealing of industry glazings and greenhouse.

DENSO®-Feu will be wrapped as insulation layer at least with one layer and, as corrosion prevention encasement, at least with two layers, which means with 50% overlap. DENSO®-Feu can be processed with a layer by layer application for components that are formed complicated and for which a spiral wrapping is not possible. During processing, the tape must be pressed evenly and the mastic must be spread especially in the overlaps.

A rockshield DEPROTEC®-DRM PP can be applied above the tape for an increased mechanical protection.

An additional petrolatum tape is available with DENSO®-Cal for the use at higher temperature requirements +110°C (+230°F).

Typical product properties (Excerpt*)

Properties	Unit	Typical value	Test method
Thickness	mm	≥ 1.0	-
Specific electrical insulation resistance	Ω m²	≥ 10 ⁶	EN 12068
Dripping point of the mastic	°C (°F)	≥ +100 (+212)	-
Carrier	-	Polypropylene nonwoven	-
UV stability	-	good	-
Operating temperature	°C (°F)	-40 to +70 (-40 to 158)	-
Processing temperature	Environment	-20 to +50 (-4 to +122)	-
	DENSO®-Feu	-10 to +40 (+14 to +104)	-

* For further product information as well as details on ordering and packaging, please refer to the product data sheet at denso-group.com.

DENSO®-Flex

Petrolatum tape for the corrosion prevention of pipelines, pipeline components and metal structures with operating Temperatures up to +30°C (+86°F).

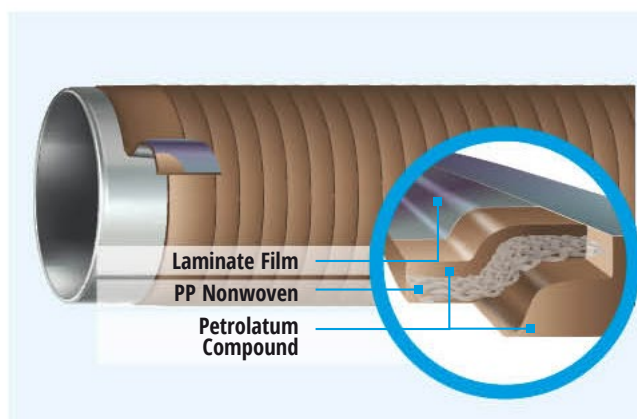

For temperatures from -50°C (-58°F) to +50°C (+122°F).



High plasticity and flexibility.



Electrically insulating and diffusion resistant.



Ideally suitable for complex surfaces of pipeline components.

DENSO®-Flex is a petrolatum tape that can be processed cold for the corrosion prevention encasement of pipelines and pipeline components, e.g. armatures, flange connections, branches and other metallic structures, in soil and water.

Beyond the application of pipeline construction, DENSO®-Flex finds **use in metal structures, grounding of lightning rods, prepressed anchors and many other components.**

DENSO®-Flex consists of an impregnated polypropylene carrier nonwoven, which is coated on both sides with a corrosion prevention petrolatum mastic. In addition DENSO®-Flex provides a **single side laminated PP film**, which prevents a washing out of the protective mass, e.g. caused by rising or falling groundwater.

DENSO®-Flex is based on more than 90 years of experience of the DENSO Group Germany in the production of high quality corrosion prevention products on petrolatum basis.

The plastic petrolatum mastic of DENSO®-Flex completely moistens the surface to be protected and seals it reliably against corrosive media such as water and oxygen.

DENSO®-Flex has a thickness of 1.5 mm and therefore offers a tight encasement already with **one winding process with 50% overlap** with a significantly **higher mechanical resistance** than comparable petrolatum tapes.

Components for which a spiral type wrapping is not possible can be protected with DENSO®-Flex using a layer by layer application.

Compatible equalization and modeling mastics on petrolatum basis are available with **DENSO®-PF Mastic** and **DENSO®-Plast Mastic** for the encasements of flanges and other complex geometries.

A rockshield **DEPROTEC®-DRM PP** or the polyurethane glass fiber fabric **DEPROTEC®-PUR** can be applied across the encasement to achieve an increased mechanical protection.

Typical product properties (Excerpt*)

Properties	Unit	Typical value	Test method
Thickness	mm	≥ 1.5	-
Specific electrical encasement resistance	Ω m²	≥ 3*10 ⁷	EN 12068
Drip resistance 48h (+50°C/+122°F)	-	no dripping	EN 12068
Carrier	-	Polypropylene nonwoven	-
Thickness PP laminate film	µm	100	-
System design	Primer	no primer	-
	Encasement	2 layers	-
Cathodic disbondment 28 days (+23°C/+73°F)	mm	≤ 4	EN 12068
Impact resistance	J	> 2	EN 12068
Indentation resistance (0.1 MPa)	mm	> 2	EN 12068
Low temperature unrolling test (-5°C/+23°F)	-	passed	EN 12068
Saponification value petrolatum mastic	mg(KOH)/ g	≤ 10	EN 12068
Operating temperature	°C (°F)	-40 to +30 (-40 to +86)	-

* For further product information as well as details on ordering and packaging, please refer to the product data sheet at denso-group.com.

DENSO®-Plast

Cold applied petrolatum tape in accordance with DIN 30672 and DIN EN 12068 for the corrosion protective encasement of pipelines, pipeline components and metal structures.

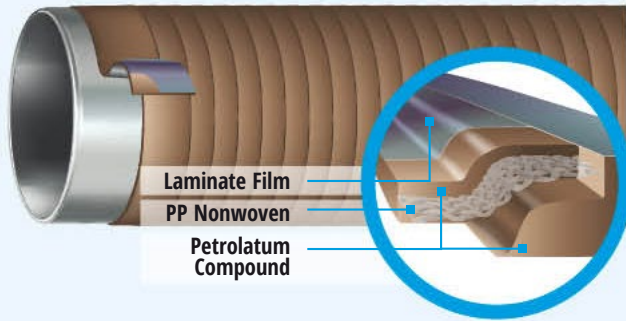

For temperatures from -50°C (-58°F) to +50°C (+122°F).



DIN-DVGW approval for stress class A 30 in accordance with DIN 30672 and EN 12068.



High plasticity and flexibility.



Ideally suitable for complex surfaces of pipeline components.



Reliable and permanent corrosion prevention.

DENSO®-Plast is a petrolatum tape in accordance with DIN 30672 and DIN EN 12068 that can be processed cold for the corrosion prevention encasement of pipelines and pipeline components, e.g. armatures, flange connections, branches and other metallic structures, in soil and water.

Beyond the application of pipeline construction, DENSO®-Plast is **used for metal structures, grounding of lightning rods or pre-pressed anchors.**

DENSO®-Plast with its advanced development is used for more than 90 years with an outstanding success and it fulfills the current quality standards for a permanent corrosion protection.

DENSO®-Plast consist of an impregnated polypropylene carrier nonwoven, which is coated on both sides with a corrosion prevention petrolatum mastic. In addition DENSO®-Plast provides a **single side laminated PP film**, which prevents a washing out of the protective mass, e.g. caused by rising or falling groundwater.

The plastic petrolatum mastic of DENSO®-Plast completely moistens the surface to be protected and seals it reliably against corrosive media such as water and oxygen.

DENSO®-Plast has a DVGW approval for stress class A 30 in accordance with DIN 30672 and DIN EN 12068 (NG-5180A00703) and it is therefore subject to frequent internal and external quality controls.

Standard designation:

- Coating DIN 30672 – A 30
- Coating EN 12068 – A 30



The encasement system DENSO®-Plast consists of three tape layers, which are either achieved with a wrapping process with 67% overlap or two wrapping processes with an inner wrapping with 50% overlap and an additional outer wrapping with 10 mm overlap. DENSO®-Plast can be processed with a layer by layer application for components that are formed complicated and for which a spiral wrapping is not possible.

Compatible equalization and modeling mastics on petrolatum basis are available with **DENSO®-PF Mastic** and the **DENSO®-Plast Mastic** for the encasements of flanges and other complex geometries.

A rockshield **DEPROTEC®-DRM PP** or the polyurethane glass fiber fabric **DEPROTEC® PUR** can be applied across the encasement to achieve an increased mechanical protection.

Typical product properties (Excerpt*)

Properties	Unit	Typical value	Test method
Thickness	mm	app. 1.1	-
Specific electrical insulation resistance	$\Omega \cdot m^2$	$\geq 3 \cdot 10^7$	EN 12068
Drip resistance 48h (+50°C/+122°F)	-	no dripping	EN 12068
Carrier	-	Polypropylen-nonwoven	-
Thickness PP-laminate film	μm	55	-
System design	Primer	no primer	-
	Encasement	3 layers	-
Impact resistance (3 layers)	J	> 4	EN 12068
Indentation resistance, 0.1 MPa rod load	mm	> 2.4	EN 12068
Cathodic disbondment resistance 28 days (+23°C/+73°F)	mm	≤ 4	EN 12068
Low temperature unrolling test (+5°C/+23°F)	-	passed	EN 12068
Saponification number (petrolatum compound)	mg(KOH)/g	≤ 10	EN 12068
Operating temperature	°C (°F)	-40°C (-40°F) to +30°C (+86°F)	-

* For further product information as well as details on ordering and packaging, please refer to the product data sheet at denso-group.com.

DENSO®-Tape ET

Multifunctional petrolatum tape for reliable corrosion prevention at high operating temperatures, particularly in hot areas.



For temperatures from -40°C (-40°F) to +75°C (+167°F).



Non-dripping and easy to apply even at warmer temperatures.



Solvent-free.



Good adhesion to mechanical protective tapes made of PE or PVC.



Very good resistance to acids, salts and alkaline substances.



Cost-effective tape with outstanding price/quality ratio.

DENSO®-Tape ET is a **multifunctional**, cold-applied, petrolatum-based corrosion prevention tape with a high-strength polypropylene non-woven inner.

It is ideal for providing **long-term corrosion protection on metallic components, fittings, flanges, pipelines and pipeline components.**

DENSO®-Tape ET is very malleable, **particularly at high temperatures**, and is easy to apply thanks to its **optimal surface wetting** characteristics.

The product includes a special high-performance additive for maximum stability, making it suitable for use even in the world's hottest countries.

To protect the user applying the tape and the environment, DENSO®-Tape ET is – like all DENSO® petrolatum-based tapes and mastics – **solvent and odour-free.**

In addition to a wide application temperature range of -40°C (-40°F) to +70°C (+158°F), DENSO®-Tape ET also shows high resistance to acids, salts and alkaline substances.

The technical performance and cost-effectiveness of DENSO®-Tape ET results in a product that offers **excellent price/quality ratio.**

DENSO®-Tape ET can also be used in conjunction with DENSO® petrolatum mastics, which are available for a range of applications.

DENSO®-Tape ET can be wrapped with 50% overlap around a surface pretreated with DENSO® mastic.

DENSO PE or PVC tapes or **DEPROTEC®-DRM PP** protective rockshields can be applied to provide additional mechanical protection.

Thanks to its **special design**, the product combines perfectly with the mechanical protective tape.

This delivers both **high impact resistance** and an additional sealed casing.

Typical product properties (Excerpt*)

Properties	Unit	Typical value	Test method
Thickness	mm	≥ 1.1	-
Dielectric strength (double-layered)	kV	≥ 16	ASTM D149
Dripping point	°C (°F)	≥ +100 (≥ +212)	EN 12068
Carrier	-	Polypropylene, non-woven	-
Tear resistance (+23°C/+73°F)	N/mm	app. 4.0	EN 12068
Peel strength on steel (+23°C/+73°F)	-	Cohesive separation pattern	EN 12068
Cathodic disbondment resistance 30d (+23°C/+73°F)	mm	≤ 5	EN 12068
Flash point	°C (°F)	≥ +150 (≥ +302)	AWWA
Processing temperature	°C (°F)	+5 to +55 (+41 to +131)	-
Operating temperature	°C (°F)	-40 to +70 (-40 to +158)	-

* For further product information as well as details on ordering and packaging, please refer to the product data sheet at denso-group.com.

DENSO®-Tape HT

Petrolatum tape for reliable corrosion prevention at high operating temperatures, particularly on moist surfaces.

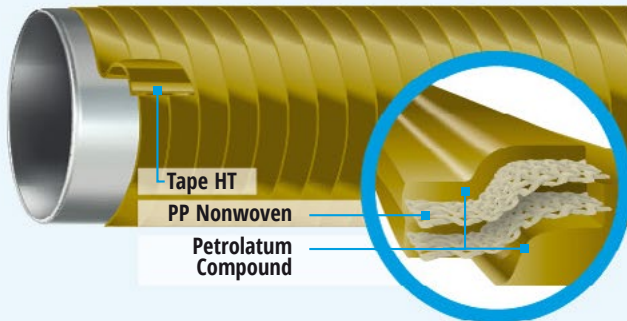

For temperatures of -50°C (-58°F) to +110°C (+230°F).



Fulfils EN 12068-A100.



Fulfils ISO 21809-3; Type 11A.



Simple processing on components with complex, irregular geometry.



Solvent-free.



Rust removal with a wire brush is sufficient.



Perfectly suited to damp substrates used in conjunction with **DENSO®-AQ Primer HT**.

DENSO®-Tape HT is a petrolatum-based corrosion prevention tape which fulfils EN 12068. More than 100 years of experience, especially with the petrolatum tapes (DENSO® Tape) invented by DENSO, have been utilised for the development of the tape and guarantee the highest quality.

DENSO®-Tape HT is made of robust, dual layer polyester non-woven fabric and a petrolatum-based corrosion prevention mastic. The petrolatum base has a **very high dripping point and gives the tape excellent adhesion – at the highest temperatures too**. DENSO®-Tape HT is therefore **ideal** for the **highest thermal loads** at permanent operating temperatures of up to +100°C (+212°F), as well as short term temperature peaks of up to +110°C (+230°F).

DENSO®-Tape HT can be used in conjunction with **DENSO® petrolatum mastics** which are available for a range of requirements. For example, **DENSO®-AQ PRIMER HT** allows moist substrates to be coated.

DENSO®-PF MASTIC HT is particularly well suited to smoothing larger geometric shapes (e.g. for coating flanges).

DENSO® Tape HT can be wrapped around a surface which has been pre-treated with a DENSO® petrolatum mastic with 50% overlap. **DENSOLEN®-ET100**, **DEPROTEC®-PUR** or a **DEPROTEC®-DRM PP** protective rockshield can also be applied to provide additional mechanical protection.

In conjunction with **DENSOLEN®-ET100**, a tight coating with high impact resistance is achieved.

DENSO®-Tape HT is a component in the **VivaxCoat®-HT** corrosion prevention system. The system includes the water-repellent corrosion prevention coating **DENSO®-AQ Primer HT** as well as the mechanical protective tape **DENSOLEN®-ET100**. The **VivaxCoat®-HT** system fulfils the requirements of EN12068 Class A100 and ISO21809-3 Type 11A.

Typical product properties (Excerpt*)

Property	Unit	Typical value	Test method
Thickness	mm	≥2.0	-
Specific electrical insulation resistance	Ω m ²	≥ 10 ⁶	EN 12068
Drip test at +120°C(+248°F)		No dripping	
Peel strength on steel ⁽¹⁾		Cohesive separation pattern	
	+23°C (+73,4°F)	-	Cohesive separation pattern
	+100°C (+212°F)	-	Cohesive separation pattern
Impact resistance ⁽²⁾	J	> 15	
Indentation resistance at +100°C(+212°F) ⁽²⁾ (10MPa, 3d)	mm (Residual coat thickness)	> 0.6	
Cathodic disbondment resistance 28 days, +23 °C (+73.4°F) ⁽¹⁾	mm (Radius)	≤ 9	
Processing temperature	°C (°F)	+5 to +50 (+41 to +122)	-
Operating temperature	°C (°F)	-40 to +100 (-40 to +212)	-
Thermal aging 100d at +120°C(+248°F) ⁽¹⁾	-	Cohesive separation pattern	EN 12068

⁽¹⁾ System with **DENSO®-AQ Primer HT**

⁽²⁾ System with **DENSO®-AQ Primer HT** and **DENSOLEN®-ET100**

* For further product information as well as details on ordering and packaging, please refer to the product data sheet at denso-group.com.

DENSO®-Tape LT

Petrolatum tape for reliable corrosion protection at low operating temperatures, especially on wet surfaces.

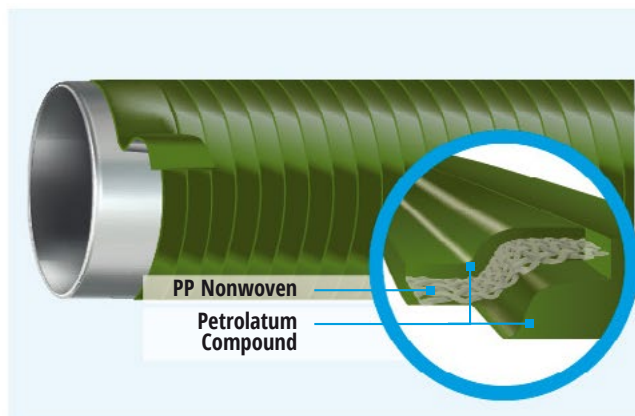

For temperatures from -40°C (-40°F) to +30°C (+86°F).



Flexible and adaptable even at low temperatures.



Solvent-free.



Manual rust removal is sufficient.



Highly suitable for use on moist substrates in combination with DENSO®-AQ Primer.



Simple to process on a wide range of pipe diameters and components.

DENSO®-Tape LT is a corrosion prevention tape that can be cold applied. It is based on petrolatum with a robust inner made from polypropylene nonwoven. It is highly suitable for **long-term corrosion prevention encasements on pipe-lines, fittings and flanges**.

DENSO®-Tape LT is also **very malleable even at low temperatures**. This corrosion prevention tape is easy to process thanks to its **optimal surface wetting**. Its outstanding price/quality ratio also sets it apart.

DENSO®-Tape LT can be used in conjunction with DENSO® petrolatum mastics which are available for a range of requirements. **DENSO®-AQ Primer** therefore enables moist substrates to be coated, for example.

DENSO®-PF MASTIC is particularly well suited to smoothing larger geometric shapes (e.g. for coating of flanges).

DENSO®-Tape LT can be wrapped with 50% overlap around a surface which has been prepared with a DENSO® mastic or primer. **DENSOLEN®-AS50**, **DEPROTEC®-PUR** or a **DEPROTEC®-DRM PP** rockshield can be applied as an additional mechanical protection.

Due to its special design, it combines perfectly with the mechanical protective tape **DENSOLEN®-AS50**. A **high impact resistance** and an additional tight encasement will be established.

DENSO®-Tape LT is part of the **VivaxCoat®-LT** corrosion prevention system.

The **VivaxCoat®** system fulfills the requirements of the GRTgaz (France) specifications for the classes HR and THR. A separate product information is available for this system.

Typical product properties (Excerpt*)

Properties	Unit	Typical value	Test method
Thickness	mm	≥ 1.9	-
Specific electrical insulation resistance	Ω m ²	≥ 10 ⁶	EN 12068
Drip test (+50°C/+122°F)	-	no dripping	EN 12068
Peel strength on steel (+23°C/+73°F)	-	Cohesive separation pattern	EN 12068
Indentation resistance (+23°C/+73°F)	mm	≥ 0.6	EN 12068
Cathodic disbondment resistance 28 days (+23°C ⁽¹⁾ /+73°F)	mm (Radius)	≤ 7	EN 12068
Processing temperature	°C (°F)	-10 to +30 (+14 to +86)	-
Operating temperature	°C (°F)	-40 to +30 (-40 to +86)	-

⁽¹⁾ System with DENSO®-AQ Primer

* For further product information as well as details on ordering and packaging, please refer to the product data sheet at denso-group.com.

DENSO®-Tape MT

Petrolatum tape for reliable corrosion protection at medium operating temperatures, especially on wet surfaces.

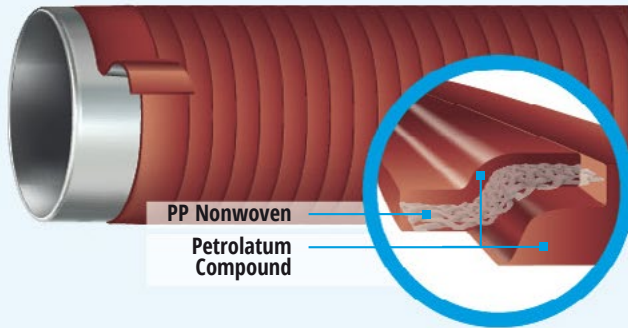

For temperatures from -50°C (-58°F) to +70°C (+158°F).



Outstanding qualification for high mechanical and thermal loads.



Solvent free.



Rust removal with a wire brush is adequate.



Highly suitable for use on moist substrates in combination with DENSO®-AQ Primer.



Easy processing on different pipe diameters and components.

DENSO®-Tape MT is a corrosion prevention tape based on petrolatum in accordance with EN 12068. More than 90 years of experience, especially with the petrolatum tapes (DENSO® Tape) invented by DENSO, have been utilized for the development of DENSO®-Tape MT.

DENSO®-Tape MT consists of a robust polypropylene nonwoven and a corrosion prevention mastic based on petrolatum, which has a **high dripping point and good adhesive resistances even at high temperatures**. Therefore, DENSO®-Tape MT is extremely **well qualified for high mechanical and thermal loads** at permanent operating temperatures of up to +60°C (+140°F), as well as short term temperatures of up to +70°C (+158°F).

DENSO®-Tape MT is used in combination with **DENSO® petrolatum mastics**, which are available for different requirements. For example, **DENSO®-AQ Primer** permits the coating of moist substrates. **DENSO®-PF Mastic** is, for example, especially qualified if large geometries must be formed (e.g. for the encasement of flanges).

DENSO®-Tape MT is wrapped with 50% overlap over a surface that was prepared with a DENSO® petrolatum mastic. **DENSOLEN®-AS50**, **DEPROTEC®-PUR** or **DEPROTEC®-DRM PP** rockshield can be applied as an additional mechanical protection.

A **high impact resistance** is achieved in combination with **DENSOLEN®-AS50** and an additional tight encasement will be established.

DENSO®-Tape MT is part of the corrosion prevention system **VivaxCoat®**, which includes DENSO®-AQ Primer, as a water repellent anti corrosion coating, as well as DENSOLEN®-AS50, as a mechanical protective tape. The system **VivaxCoat®** fulfills the requirements of the specifications of GRTgaz (France) for the classes HR and THR.

Typical product properties (Excerpt*)

Properties	Unit	Typical value	Test method
Thickness	mm	≥ 1.7	-
Specific electrical insulation resistance	Ω.m ²	≥ 10 ⁶	EN 12068
Dripping test (+50°C/+122°F)		no dripping	EN 12068
Cathodic disbondment resistance 28 days (+23°C ⁽¹⁾ /+73°F)	mm (Radius)	≤ 7	EN12068
Peel strength on steel		Cohesive separation pattern	EN 12068
		Cohesive separation pattern	EN 12068
Impact resistance ⁽²⁾	J	> 15	EN 12068
Indentation resistance (+60°C/+140°F) ⁽²⁾ (10MPa, 3d)	mm (Residual layer thickness)	> 1.1	EN 12068
Resistance against microorganism (peel test) ⁽¹⁾	-	Cohesive separation pattern	EN 10329
Heat aging 100 days (+80°C/+176°F) ⁽¹⁾	-	Cohesive separation pattern	EN12068
Processing temperature	°C (°F)	-10 to +50 (+14 to +122)	-
Operating temperature	°C (°F)	-40 to +60 (-40 to +140)	-

⁽¹⁾ System with DENSO®-AQ Primer

⁽²⁾ System with DENSO®-AQ Primer and DENSOLEN®-AS50

* For further product information as well as details on ordering and packaging, please refer to the product data sheet at denso-group.com.

DENSO®-Tape ST

Multifunctional petrolatum tape for reliable corrosion prevention with optimised surface wetting and simple application, particularly in cold areas.



For operating temperatures of -40°C (-40°F) to +45°C (+113°F).



Flexible and adaptable even at low temperatures.



Solvent-free.



Good adhesion to mechanical protective tapes made of PE or PVC.



Very good resistance to acids, salts and alkaline substances.



Cost-effective tape with outstanding price/quality ratio. Suitable for a wide range of applications.

DENSO®-Tape ST is a **multifunctional**, cold-applied, petrolatum-based corrosion prevention tape with a high-strength polypropylene non-woven inner. It is ideal for providing **long-term corrosion protection on metallic components, fittings, flanges, pipelines and pipeline components.**

DENSO®-Tape ST is very **malleable even at low temperatures**, and is easy to apply thanks to its **optimal surface wetting** characteristics.

To protect the user applying the tape and the environment, DENSO®-Tape ST is – like all DENSO® petrolatum-based tapes and mastics – **solvent and odour-free.**

In addition to a wide application temperature range of -40°C (-40°F) to +45°C (+113°F), DENSO®-Tape ST also shows high resistance to acids, salts and alkaline substances.

The outstanding performance and cost-effectiveness of DENSO®-Tape ST results in a product that offers an **excellent price/quality ratio.**

DENSO®-Tape ST can also be used in conjunction with DENSO® petrolatum mastics, which are available for a range of applications.

DENSO®-Tape ST can be wrapped with 50% overlap around a surface pretreated with DENSO® mastic. **DENSO PE or PVC tapes** or **DEPROTEC®-DRM PP** protective rockshields can be applied to provide additional mechanical protection.

Thanks to its **special design**, the product combines perfectly with the mechanical protective tape. This delivers both **high impact resistance** and an additional sealed casing.

Typical product properties (Excerpt*)

Properties	Unit	Typical value	Test method
Thickness	mm	1.15	-
Dielectric strength (double-layered)	kV	≥ 16	ASTM D149
Dripping point	°C (°F)	≥ +100 (≥ +212)	EN 12068
Carrier	-	Polypropylene, non-woven	-
Tear resistance (+23°C/+73°F)	N/mm	app. 4.0	EN 12068
Peel strength on steel (+23°C/+73°F)	-	Cohesive separation pattern	EN 12068
Cathodic disbondment resistance 30d (+23°C/+73°F)	mm	≤ 5	EN 12068
Flash point	°C (°F)	≥ +150 (≥ +302)	AWWA
Processing temperature	°C (°F)	+5 to +45 (+41 to +113)	-
Operating temperature	°C (°F)	-40 to +45 (-40 to +113)	-

* For further product information as well as details on ordering and packaging, please refer to the product data sheet at denso-group.com.

DENSO®-Tec

Plastic petrolatum tape for sealing and for corrosion prevention at metallic components, pipes and armatures with operating temperatures up to +35°C (+95°F).

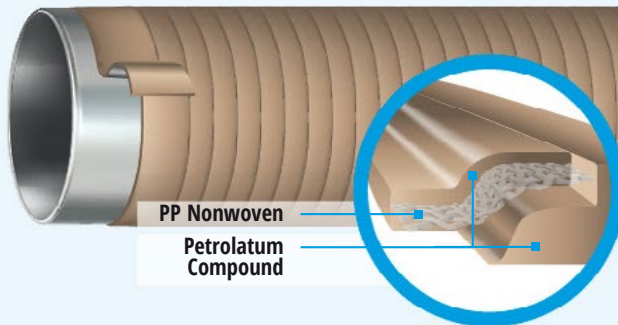

For temperatures of -40°C (-40°F) to +50°C (+122°F).



High plasticity and flexibility.



Electrically insulating and diffusion resistant.



Ideally suitable for complex surfaces of pipeline components.

DENSO®-Tec is a corrosion prevention tape that can be processed cold on the basis of petrolatum.

DENSO®-Tec consist of an impregnated polypropylene carrier nonwoven, which is coated on both sides with a corrosion prevention petrolatum mastic. The petrolatum mastic is stabilized by polymer additives, which means that it can be used at operating temperatures of -40°C (-40°F) to +35°C (+95°F).

DENSO®-Tec is impermeable for water and highly resistant against hydrous electrolyte solution.

DENSO®-Tec is based on more than 90 years of experience of the DENSO Group Germany in the production of high quality corrosion prevention products on petrolatum basis.

DENSO®-Tec is used in many applications, e.g. as

- Corrosion prevention for structural metallic components in buildings and above ground systems
- Corrosion prevention of metal parts or pipe systems inserted into concrete or screed

- Galvanic separation layer for metallic constructions
- Corrosion prevention of cooling lines or heat insulating insulations

DENSO®-Tec will be wrapped as insulation layer at least with one layer and, as corrosion prevention encasement with 50% overlap, at least with two layers, or processed layer by layer with an adequate overlap.

An alternative corrosion prevention tape with a laminated PP film is available with **DENSO®-Plast** for buried pipelines, which provides an increased resistance against washing out, e.g. due to rising and falling groundwater.

DENSO®-Tape MT (+60°C/+140°F), **DENSO®-Feu** (+70°C/+158°F) and **DENSO®-Cal** (+110°C/+230°F) are additional corrosion prevention tapes with the proven DENSO quality for applications with higher temperature requirements.

Typical product properties (Excerpt*)

Properties	Unit	Typical value	Test method
Thickness	mm	app. 1.1	-
Specific electrical insulation resistance	$\Omega \cdot m^2$	$\geq 10^7$	EN 12068
Drip resistance 48h (+50°C/+122°F)	-	no dripping	EN 12068
Dripping point	°C (°F)	app. +60 (+140)	-
Carrier	-	Polypropylene nonwoven	-
Low temperature unrolling test (-5°C/+23°F)	-	passed	EN 12068
Saponification value (petrolatum mastic)	mg KOH / g	≤ 10	EN 12068
UV stability	-	good	-
Operating temperature	°C (°F)	-40 to +35 (-40 to +95)	-

* For further product information as well as details on ordering and packaging, please refer to the product data sheet at denso-group.com.

DENSO®-Verte

Plastic petrolatum tape for sealing and corrosion prevention at metallic components, cable connections, pipelines and armatures.

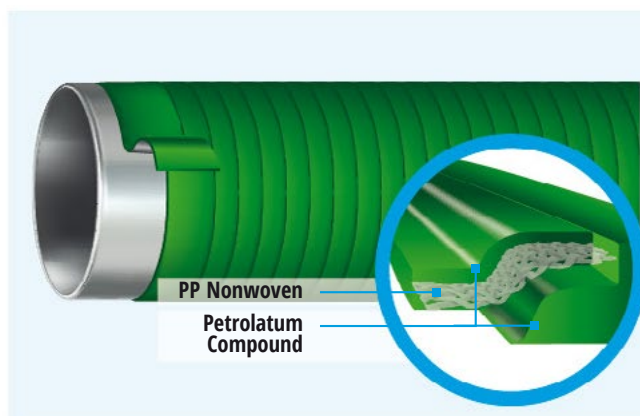

For temperatures from -50°C (-58°F) to +50°C (+122°F).



Flexible and adaptable.



Resistant against acids, lyes and salts.



Impermeable for water and gas.



Fulfills GrDF standard MBAA023 and BAA023.

DENSO®-Verte is a cold applied corrosion prevention tape based on petrolatum in accordance with EN 12068 and it fulfills the standards MBAA023 and BAA023 of Gaz Réseau Distribution France (GRDF).

DENSO®-Verte consists of an impregnated polypropylene carrier nonwoven, which is coated on both sides with a corrosion prevention petrolatum mastic. The petrolatum mastic is stabilized by polymer and mineral additives, which means that it can be used at design temperatures of -50°C (+58°F) and up to +50°C (+122°F).

DENSO®-Verte is moisture impermeable and highly resistant against acids, lyes and salts.

DENSO®-Verte is based on more than 90 years of experience of DENSO Group Germany in the production of high quality corrosion prevention products on petrolatum basis.

DENSO®-Verte is used in many applications, e.g. as

- Corrosion prevention for structural metallic components in buildings and above ground systems;
- Corrosion prevention of metal parts or pipe systems inserted into concrete or screed;
- Galvanic separation layer for metallic constructions;
- Temporary sealing of leaks in low-pressure gas pipes.

DENSO®-Verte will be wrapped as insulation layer at least with one layer and, as corrosion prevention encasement, at least with two layers, which means wrapped with at least 50% overlapping or layer-by-layer with appropriate overlapping.

A rockshield **DEPROTEC®-DRM PP** or the polyurethane glass fiber fabric **DEPROTEC®-PUR** can be applied across the encasement to achieve an increased mechanical protection.

DENSO®-Tape MT (+60°C/+140°F), **DENSO®-Feu** (+70°C/+158°F) and **DENSO®-Cal** (+110°C/+230°F) are additional corrosion prevention tapes with the proven DENSO quality for applications with higher temperature requirements.

Typical product properties (Excerpt*)

Properties	Unit	Typical value	Test method
Thickness	mm	app. 1.1	-
Specific electrical insulation resistance	$\Omega \text{ m}^2$	$\geq 10^{10}$	EN 12068
Dripping point	$^{\circ}\text{C}$ ($^{\circ}\text{F}$)	app. +60 (+140)	-
Color	-	brown-green	-
Carrier	-	Polypropylene nonwoven	-
Dielectric strength	kV / mm	≥ 9	-
Tape strength	N / cm	≥ 60	EN 12068
Elongation at break	%	≥ 7	DIN 30672
Saponification number	mg KOH / g	≤ 0.25	EN 12068
Operating temperature	$^{\circ}\text{C}$ ($^{\circ}\text{F}$)	-40 $^{\circ}\text{C}$ (-40 $^{\circ}\text{F}$) to +30 $^{\circ}\text{C}$ (+86 $^{\circ}\text{F}$)	-

* For further product information as well as details on ordering and packaging, please refer to the product data sheet at denso-group.com.

DENSO®-TB System

Highly effective corrosion protection and sealing system for the transition area from steel to concrete in above-ground tank bases.

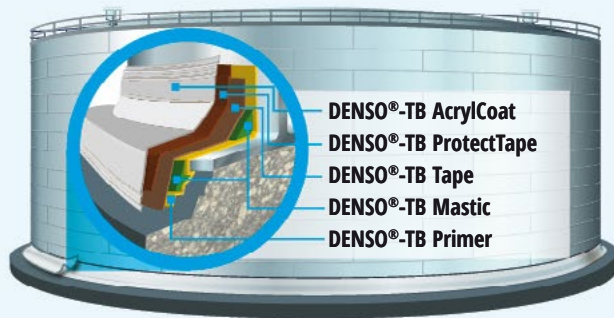

For service temperatures up to +80°C (+176°F).



Easy application, without special pretreatment, even on moist surfaces.



Flexible and adaptable in the entire application temperature range.



Solvent free corrosion prevention system. No risk of explosion or skin burns during application.



Waterproof and eco-friendly.



Can be applied manually without special equipment.

Tank bases of above ground storage tanks are frequently exposed to progressing corrosion. Due to gaps between the bottom steel plate and concrete base, air and water can penetrate and start corroding this area of the tank. This may lead, in worst case, to a replacement of the tank or a total shutdown.

DENSO®-TB System is a protective system for the transition zone, steel-concrete, at above ground tank bases. It provides the combination of an excellent corrosion and weather protection for operating temperatures up to +80°C (+176°F).

DENSO®-TB System is cost effective protection system to protect the outer tank base against corrosion and contributes to economical repair and increases the service life of the tanks. It can be easily applied manually. Even a layer of condensation, which precludes the application of conventional anti corrosion systems, does not prevent DENSO®-TB System from working effectively. Additionally, the system convinces through its flexibility and adaptability in the entire application temperature range.

The system consists of:

- DENSO®-TB Primer**
- DENSO®-TB Mastic**
- DENSO®-TB Tape**
- DENSO®-TB ProtectTape**
- DENSO®-TB AcrylCoat**

DENSO®-TB Primer permits an easy coating of metallic or concrete surfaces, manually or with a putty knife. A special formulation permits the application even for moist substrates.

DENSO®-TB Mastic is a waterproof and eco-friendly self-supporting mastic for sealing and shaping to the transition area of irregular profiles.

DENSO®-TB Tape is very malleable in the entire application temperature range and due to its optimal surface wetting, this petrolatum-based corrosion prevention tape is easy to process and has a robust inner made from polypropylene nonwoven. Due to its special design, it connects perfectly with the mechanical protective tape.

DENSO®-TB ProtectTape creates a highly resistant mechanical encasement above the corrosion prevention coating. Due to the strong connection between the corrosion prevention tape and the mechanical protective tape, a very compact and stable overall system is achieved.

DENSO®-TB AcrylCoat is a UV-resistant top coat as additional protection and a visual completion of the applied corrosion protection system. Customers may use their own coatings, if technically equivalent to DENSO®-TB AcrylCoat, to achieve a colour shade that matches with the usual colour scheme of their storage tank coatings.

Product processing: Please refer to the separate DENSO®-TB System application recommendation.

Typical product properties (Excerpt*)

Properties	Unit	DENSO®-TB				
		Primer	Mastic	Tape	Protection Tape	AcrylCoat
Density	g/cm ³	1,1	0,55	-	-	1,0
Thickness	mm	-	-	1,1	0,7	-
Colour	-	green-brown	brownish	dark brown	inside black	white (standard) Project-specific colour possible (min. 500L)
Dripping point	°C (°F)	≥+120 (+248)	≥+100 (+212)	≥+100 (+212)	-	-
Cathodic disbondment resistance 30d / +23°C (+73°F) system	mm	≤ 10				
Dielectric strength	kV	≥ 35				
Maximum service temperature	°C (°F)	Up to +80°C (+176°F)				
Resistance to oil, gasoline, kerosene	-	good				

* For further product information as well as details on ordering and packaging, please refer to the product data sheet at denso-group.com.

DENSO-Tape: An idea that changed everything.

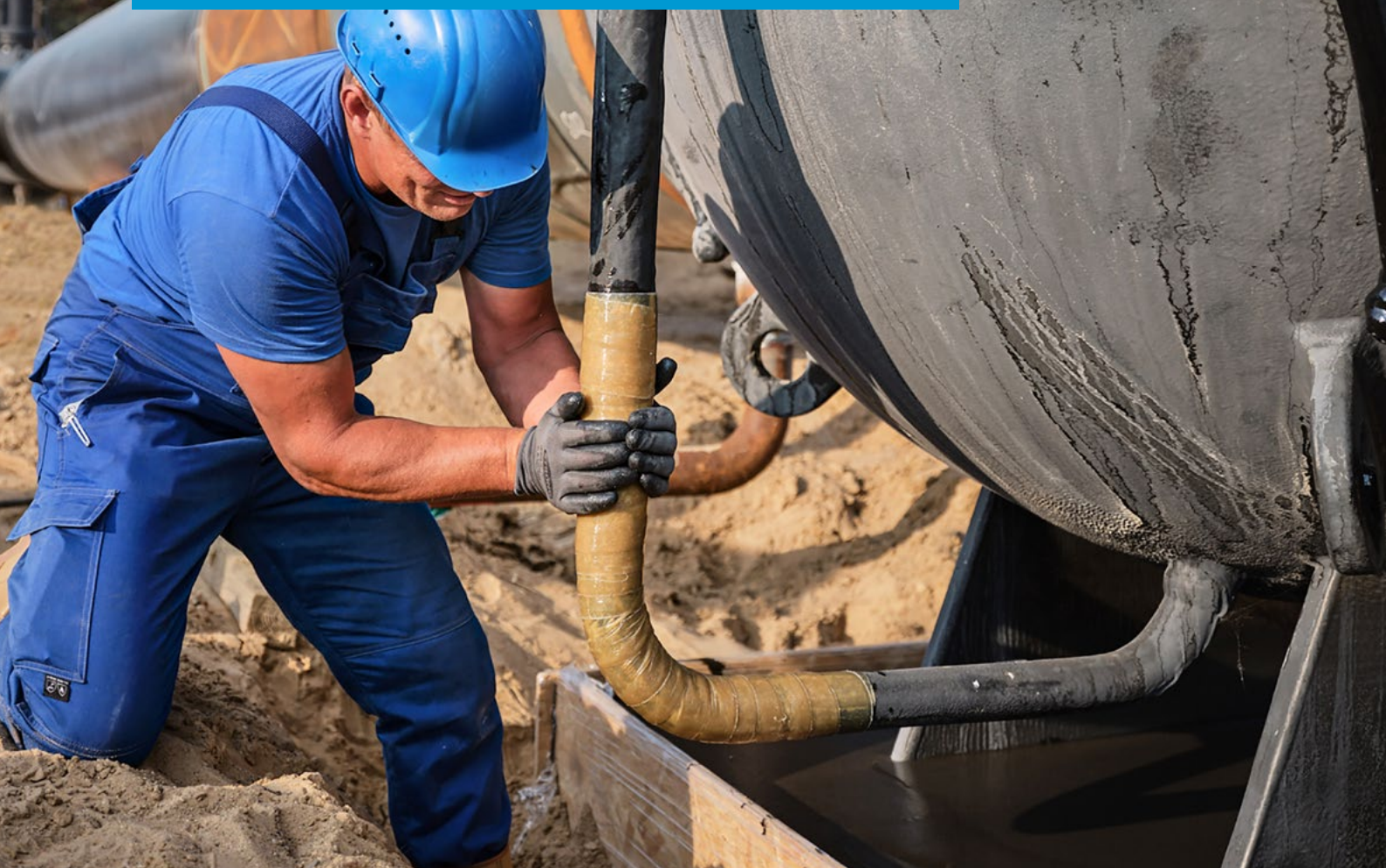

In **1927**, the chemist **Paul Schade** researched a safe and durable solution to protect pipes from corrosion: He used a fabric tape which he coated with Vaseline. - A great idea.

In the same year for the "Schade's plastic protective bandage" the trademark **DENSO** was registered. Since then the DENSO® Tape revolutionises passive corrosion protection worldwide and becomes a synonym for **reliable protection** of pipelines and ensures **maximum safety** – all over the world.

DENSO. Always one step ahead:
In the beginning with an idea.
Today with **top quality solutions**.

denso-group.com



made in
Germany
since 1922



VivaxCoat®

Protection Systems for Wet Surfaces

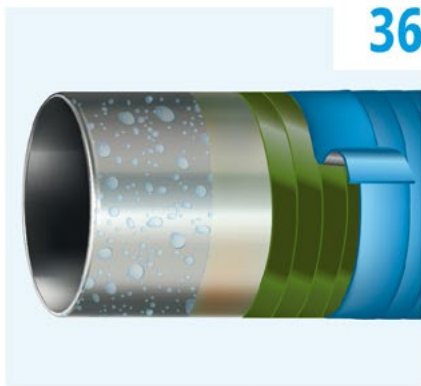

36

VivaxCoat®-LT

VivaxCoat®-LT is a coating system for permanent corrosion protection of moist steel pipes and fittings at **low operating temperatures**. Suitable for pipes with a condensation film on which conventional coating systems cannot be used.

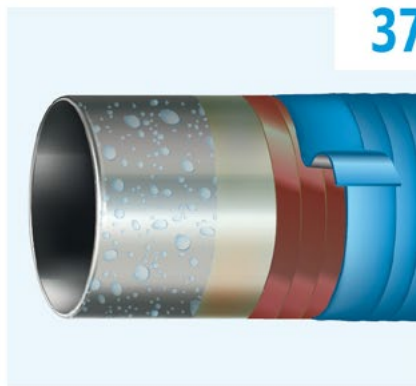

37

VivaxCoat®-MT

VivaxCoat®-MT is a coating system for permanent corrosion protection of moist steel pipes and fittings at **medium operating temperatures**. Suitable for pipes with a condensation film on which conventional coating systems cannot be used.

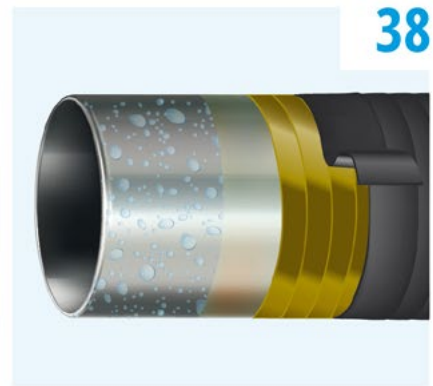

38

VivaxCoat®-HT

The VivaxCoat®-HT coating system has been specially developed for use on wet surfaces and at **high temperatures** of up to +100°C (+212°F). Pipelines in operation under high humidity are optimally protected.

VivaxCoat®-LT

Coating system for a permanent corrosion prevention of steel pipes, armatures in new building and rehabilitation.

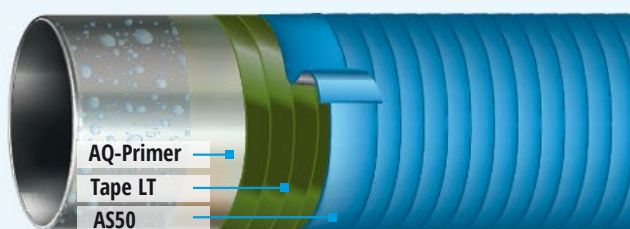

- For temperatures from -50°C to +70°C (-58°F to +158°F).
- Fulfills class HR und THR in accordance with SG 0130-01 of GRTgaz France.
- Easy application, without special pre-treatment, on moist surfaces.
- Coating of pipes under load is possible.
- Solvent-free.
- Very good resistance against salt containing atmospheres and soils.

VivaxCoat®-LT is a durable corrosion protection system which has been specifically designed for use on **moist substrates**.

Moist surfaces often pose a particular challenge, particularly for the **rehabilitation** of old pipeline coatings. The unique combination of a modified, petrolatum-based corrosion protection tape with a PE/butyl rubber tape opens up new and efficient options for pipeline rehabilitation.

Even a **layer of condensation**, which precludes the application of conventional field coating systems, does not prevent VivaxCoat®-LT from working effectively.

Such **moist surfaces** can be found, for example, on pipelines that are under load or which are exposed to high humidity.

Pipeline downtimes or long waiting times during the coating work will be prevented and **costs significantly reduced** by using VivaxCoat®-LT.

VivaxCoat®-LT is especially suitable for permanent corrosion prevention of pipelines installed in the soil, armatures and flanges with permanent operating temperatures up to +30°C (+86°F).

The system fulfills the requirements of SG 0130-01 of GRTgaz (France) for the classes HR and THR.

The **corrosion prevention system VivaxCoat®-LT** consists of the coating mastic **DENSO®-AQ Primer**, the corrosion prevention tape **DENSO®-Tape LT** as well as **DENSOLEN®-AS50** the mechanical protective tape.

DENSO®-AQ Primer permits an easy coating of metallic pipelines and armatures, manually or with a putty knife. A special formulation permits the outstanding wetting even for moist substrates.

DENSO®-Tape LT is very malleable even at low temperatures and due to its optimal surface wetting, this petrolatum-based corrosion prevention tape is easy to process and has a robust inner made from polypropylene nonwoven. Due to its special design, it combines perfectly with the mechanical protective tape. Its outstanding price/quality ratio also sets it apart.

DENSOLEN®-AS50 creates an extremely resistant mechanical encasement around the corrosion prevention coating. Spirally wrapped, it amalgamates with itself and forms a closed hose.

Due to the strong connection between the corrosion prevention tape and the mechanical protective tape, a very compact and stable overall system is achieved.

Typical product properties (Excerpt*)

Property	Unit	Typical value		Test method
Priming-Paste	-	DENSO®-AQ-Primer		
Corrosion prevention tape	-	DENSO®-Tape LT (2 layers)		
Mechanical protection tape	-	DENSOLEN®-AS50 (2 layers)	DENSOLEN®-AS50 (4 layers)	
Operating temperature	°C (°F)	-40°C to +30°C (-40°F to +86°F)		-
Dripping point DENSO®-AQ Primer	°C (°F)	> +100 (> +212)		ISO 21809-3
Dripping point DENSO®-Tape LT	°C (°F)	app. +60 (app. +140)		ISO 21809-3
Thickness (system)	mm	≥ 6.3	≥ 8.5	ISO 21809-3
Indentation resistance (+23°C/+73°F) (Remaining layer thickness) (3 days, 10MPa)	mm	> 1.8	> 4.0	ISO 21809-3
Impact resistance	J	≥ 15	≥ 20	ISO 21809-3
Specific electrical insulation resistance**	Ω m ²	> 10 ⁸	> 10 ⁸	ISO 21809-3
Peel strength on pipe surface (+23°C/+73°F)	-	Cohesive separation pattern	Cohesive separation pattern	ISO 21809-3
Peel strength on PE factory coating (+23°C/+73°F)	-	Cohesive separation pattern	Cohesive separation pattern	ISO 21809-3
Peel strength on steel after thermal aging 28days, (+30°C/86°F) (+23°C/+73°F)	-	Cohesive separation pattern	Cohesive separation pattern	ISO 21809-3
Cathodic disbondment resistance 28 days, (+23°C/+73°F) (radius)	mm	≤ 9		ISO 21809-3

*Valid for entire system

*** For further product information as well as details on ordering and packaging, please refer to the product data sheet at denso-group.com.**

VivaxCoat®-MT

Coating system for a permanent corrosion prevention of steel pipes, armatures in new building and rehabilitation.

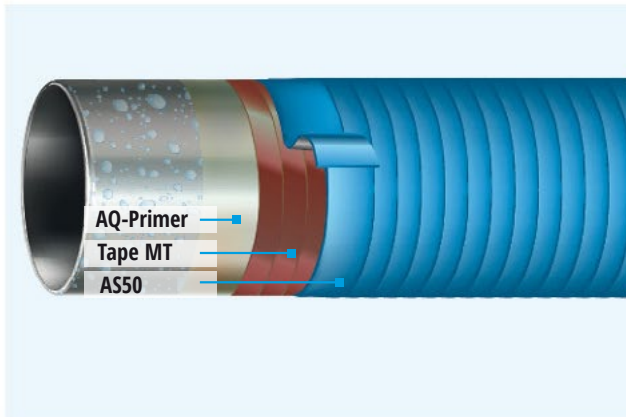

For temperatures from -50°C to +70°C (-58°F to +158°F).



Fulfills class HR und THR in accordance with SG 0130-01 of GRTgaz France.



Easy application, without special pre-treatment, on moist surfaces.



Coating of pipes under load is possible.



Solvent-free.



Very good resistance against salt containing atmospheres and soils.

VivaxCoat®-MT is a durable corrosion protection system which has been specifically designed for use on **moist substrates**.

Moist surfaces often pose a particular challenge, particularly for the **rehabilitation** of old pipeline coatings. The unique combination of a modified, petrolatum-based corrosion protection tape with a PE/butyl rubber tape opens up new and efficient options for pipeline rehabilitation.

Even a **layer of condensation**, which precludes the application of conventional field coating systems, does not prevent VivaxCoat®-MT from working effectively.

Such **moist surfaces** can be found, for example, on pipelines that are under load or which are exposed to high humidity.

Pipeline downtimes or long waiting times during the coating work will be prevented and **costs significantly reduced** by using VivaxCoat®-MT.

VivaxCoat®-MT is especially suitable for permanent corrosion prevention of pipelines installed in the soil, armatures and flanges with permanent operating temperatures up to +60°C (+140°F).

The system fulfills the requirements of SG 0130-01 of GRTgaz (France) for the classes HR and THR.

The corrosion prevention system **VivaxCoat®-MT** consists of the coating mastic **DENSO®-AQ Primer**, the corrosion prevention tape **DENSO®-Tape MT** as well as **DENSOLEN®-ASS50** the mechanical protective tape.

DENSO®-AQ Primer permits an easy coating of metallic pipelines and armatures, manually or with a putty knife. A special formulation permits the outstanding wetting even for moist substrates.

DENSO®-Tape MT is a corrosion prevention tape that can be easily processed; it is based on petrolatum with a robust inner made from polypropylene nonwoven. Due to its special design, it combines perfectly with the mechanical protective tape.

DENSOLEN®-ASS50 creates an extremely resistant mechanical encasement around the corrosion prevention coating. Spirally wrapped, it amalgamates with itself and forms a closed hose.

Due to the strong connection between the corrosion prevention tape and the mechanical protective tape, a very compact and stable overall system is achieved.

Typical product properties (Excerpt*)

Property	Unit	Typical value		Test method
Priming-Paste	-	DENSO®-AQ-Primer		
Corrosion prevention tape	-	DENSO®-Tape MT (2 layers)		
Mechanical protection tape	-	DENSOLEN®-ASS50 (2 layers)	DENSOLEN®-ASS50 (3 layers)	
Operating temperature	°C (°F)	-40°C to +60°C (-40°F to +140°F)		-
Dripping point DENSO®-AQ Primer	°C (°F)	> +100 (> +212)		ISO 21809-3
Dripping point DENSO®-Tape MT	°C (°F)	app. +80 (app. +176)		ISO 21809-3
Thickness (system)	mm	≥ 5.9	≥ 7.0	ISO 21809-3
Indentation resistance (+23°C/+73°F) (Remaining layer thickness) (3 days, 10MPa)	mm	≥ 3.0	≥ 5.0	ISO 21809-3
Impact resistance	J	≥ 15	≥ 20	ISO 21809-3
Specific electrical insulation resistance**	RS100	> 10 ⁶	> 10 ⁶	ISO 21809-3
	RS100/RS70	> 0.8	> 0.8	
Peel strength on pipe surface (+23°C/+73°F)	-	Cohesive separation pattern	Cohesive separation pattern	ISO 21809-3
Peel strength on PE factory coating (+23°C/+73°F)	-	Cohesive separation pattern	Cohesive separation pattern	ISO 21809-3
Peel strength on steel after thermal aging 28days, (+30°C/86°F) (+23°C/+73°F)	-	Cohesive separation pattern	Cohesive separation pattern	ISO 21809-3
Cathodic disbondment resistance 28 days, (+23°C/+73°F) (radius)	mm	≤ 9		ISO 21809-3

*Valid for entire system

*** For further product information as well as details on ordering and packaging, please refer to the product data sheet at denso-group.com.**

VivaxCoat®-HT

Coating system offering permanent corrosion prevention for steel pipes, armatures in new buildings and for restoration work.

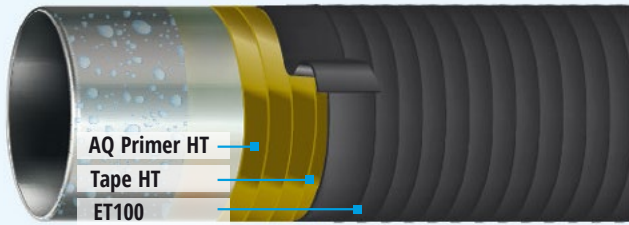

For temperatures of -50°C to +100°C (-58°F to +212°F).



Fulfils EN 12068-A100.



Fulfils ISO 21809-3; Type 11A.



Can be applied to moist surfaces without special pre-treatment.



Coating of pipes in operation possible.



Solvent-free.



Very good resistance to salty atmospheres and soils.

VivaxCoat®-HT is a durable corrosion protection system which has been specifically designed for use on **moist substrates**.

Moist surfaces often pose a particular challenge, particularly when **restoring** old coatings on piping systems. The unique combination of a modified, petrolatum-based corrosion protection tape with a PE/butyl rubber tape opens up new and efficient options for restoring piping.

Even a **layer of condensation**, which precludes the application of customary post-factory coating systems, does not prevent **VivaxCoat®-HT** from working effectively.

Such **moist surfaces** can be found, for example, on pipelines that are under strain or in areas where air humidity is high.

Using **VivaxCoat®-HT** means that pipeline interruptions or long waiting times for coating work to be processed can be avoided, thus **reducing costs significantly**.

VivaxCoat®-HT is especially suitable for permanent corrosion prevention of buried pipelines, armatures and flanges with operating temperatures of up to +100°C (+212°F). The system fulfils the requirements of EN12068 Class A100 and ISO21809-3 Type 11A.

The **VivaxCoat®-HT** corrosion protection system comprises the **DENSO®-AQ Primer HT**, the **DENSO®-Tape HT** corrosion protection tape and the mechanical protective tape **DENSOLEN®-ET100**.

DENSO®-AQ Primer HT allows metallic pipelines and armatures to be coated with ease, either manually or with a putty knife. A special formulation enables outstanding wetting, even for moist substrates.

DENSO®-Tape HT is very malleable in the processing temperature range and thanks to its optimal surface wetting, this petrolatum-based corrosion protection tape is easy to process and has a robust polyester non-woven carrier material. Due to its special qualities, it combines perfectly with the mechanical protective tape. Its outstanding price/quality ratio also sets it apart.

DENSOLEN®-ET100 creates an extremely mechanically-resistant coating around the corrosion protection layer. It welds itself with an overlapping winding effect and thereby forms a closed pipe.

Thanks to the strong connection between the corrosion protection tape and the mechanical protective tape, a very compact and stable overall system is achieved.

Typical product properties (Excerpt*)

Property	Unit	Typical value	Test method
Priming-Paste	-	DENSO®-AQ-Primer HT	
Corrosion prevention tape	-	DENSO®-Tape HT (2 layers)	
Mechanical protection tape	-	DENSOLEN®-ET100 (2 layers)	
Operating temperature	°C (°F)	-40 to +100 (-40 to +212)	-
Dripping point DENSO®-AQ Primer HT	°C (°F)	≥+120 (≥+248)	
Dripping point DENSO®-Tape HT	°C (°F)	≥+120 (≥+248)	
Thickness (system)	mm	≥ 6.3	
Indentation resistance (+23°C/+73°F) (Remaining layer thickness) (3 days, 10MPa)	mm	> 0.8	
Impact resistance	J/mm	≥ 2,4	
Specific electrical insulation resistance**	RS100 RS100/RS70	Ω m² > 10⁸ > 0.8	ISO 21809-3
Peel strength on pipe surface (+23°C/+73°F)	-	Cohesive separation pattern	
Peel strength on PE factory coating (+23°C/+73°F)	-	Cohesive separation pattern	
Peel strength on steel after thermal aging 28days, (+30°C/86°F) (+23°C/+73°F)	-	Cohesive separation pattern	
Cathodic disbondment resistance 28 days, (+23°C/+73°F) (radius)	mm	≤ 9	

*Valid for entire system

*** For further product information as well as details on ordering and packaging, please refer to the product data sheet at denso-group.com.**







42

DENSOLEN® Primer & Mastics

DENSOLEN® Primer is the perfect basis for all DENSOLEN® Tapes and guarantees the ideal finish of a surface preparation. The mastics based on butyl rubber fill in unevenness and, thanks to their permanently malleable properties, also ideally absorb movements.



44

DENSOLEN® Single Tape Systems

Real co-extruded 3-ply tapes. A comprehensive corrosion prevention and mechanical prevention is achieved with only one tape. The outer and inner wrapping amalgamate completely due to the 3-ply design of the tape.



50

DENSOLEN® Multi Tape Systems

The inner layer made of a self-amalgamating 3-ply tape provides a permanent corrosion prevention. The outer layer consists of a robust two or three-layer tape and protects the inner layer reliably against mechanical stresses.

DENSOLEN®-HT, -HT25, -HT100, -MT25 Primer

Solvent based primer for DENSOLEN® tapes and tape systems.

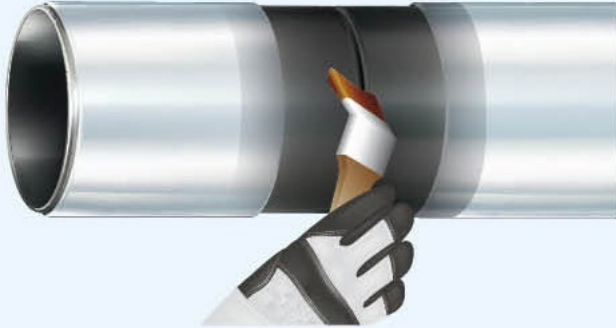

For temperatures from 60°C (76°F) to +100°C (+212°F).



Perfectly adapted to DENSOLEN® tapes and tape systems.



Outstanding resistance against cathodic disbondment.



For steel and other metal surfaces.



Dries fast and is easy to apply.



Compatible with factory coatings made of PE, PP, FBE, PU, CTE and bitumen.



For application with roller or brush.

DENSOLEN®-HT/-MT Primer is an integral part of all **DENSOLEN®** tape systems and is applied as prime coat before the wrapping of the **DENSOLEN®** tapes on the metal surface and adjacent factory coatings.

DENSOLEN®-HT/-MT Primer is based on naphtha (petroleum spirit) and it includes butyl rubber as well as resins for an optimal adhesive connection between the DENSOLEN® tapes and the pipe surface.

DENSOLEN®-HT/-MT Primer is available on the basis of two solvents with different volatilization ranges. This means that optimal processing conditions are achieved for **cold** (e.g., DENSOLEN®-HT Primer as well as **warm** (e.g. DENSOLEN®-MT25 Primer) **climatic conditions**.

DENSOLEN®-HT/-MT Primer provide a high yield. A thin covering coating is adequate. The areal coverage is app. 0.2 liter per m².

DENSOLEN®-HT/-MT Primer improves the peel strength of DENSOLEN® tape systems on the metal surface as well as on the factory coating and therefore supports the permanent corrosion protection.

The surface must be cleaned (surface cleanliness ST2 or SA 2.5 in accordance with ISO 8501-1) before DENSOLEN®-HT/-MT Primer is applied.

It is recommended to repeat the prime coat at the latest after 6 hours if the application of a DENSOLEN® tape system cannot be started immediately after the drying of the primer.

DENSOLEN®-HT/-MT Primer can be processed with a brush or a painter's roller.

The prime coat must be dry before the application of the DENSOLEN® tapes. The drying time is approximately 5 to 25 minutes depending on the primer type, the ambient temperature, the air movement and the moisture.

Typical product properties (Excerpt*)

Property	Unit	Typical value				Test method	
		HT	HT25	HT100	MT25		
Solvents	-	Petroleum spirit	Petroleum spirit	Petroleum spirit	Petroleum spirit	-	
Density	(+23°C/+73°F)	g/cm ³	0.79	0.78	0.80	0.80	DIN 51757
Solids content	wt%	30	24	30	≥ 24	ISO 1515	
Drying time for manual application ¹⁾	min (app.)	5 to 10	5 to 10	10	20 to 25	-	
Maximum waiting time for the DENSOLEN® tape application	h			< 8		-	
Consumption	l/m ²			0.2		-	
Operating temperature ²⁾	°C (°F)			-60 to +100 (-76 to +212)		-	

¹⁾ Depending on the temperature, humidity, air movement and surface temperature of the pipe.
²⁾ Depending on the DENSOLEN® tape system used.

* For further product information as well as details on ordering and packaging, please refer to the product data sheet at denso-group.com.

DENSOLEN®-W/ -W+/ -WP Mastic

Butyl rubber mastic for the filling of cavities and the forming of transitions for corrosion prevention coatings with DENSOLEN® tape systems.

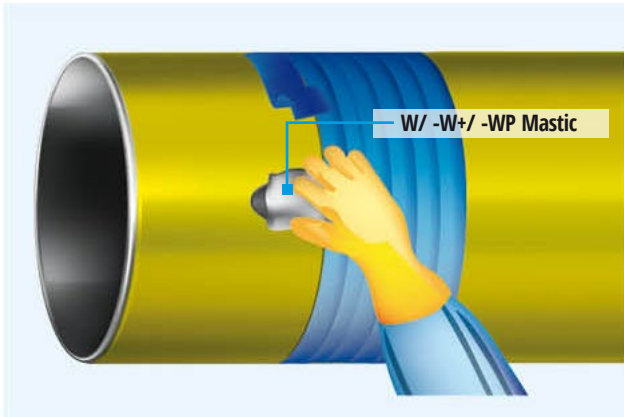

For temperatures from -50°C (-58°F) to +85°C (+185°F).



Seals cavities reliably.



Easily adaptable to edges and chamfers.



Outstanding interaction with all DENSOLEN® tapes.



Permanent plastic.



Available in many practical dimensions.

DENSOLEN®-Mastic is a permanent plastic butyl rubber filling mastic, which can be formed by hand, for the **equalization of uneven surfaces** before the application of DENSOLEN® tapes.

DENSOLEN®-Mastic is ideally qualified to **equalize unevennesses such as high welding seams**. DENSOLEN®-Mastic connects itself through a **self-amalgamation** effect with the butyl rubber layer of the DENSOLEN® tape and therefore provides a complete cover of the surface. Cavities or cracks will be closed reliably and a permanent corrosion prevention will be built up.

The **filling of chamfers for T-fittings, the equalization of the transition of the steel surface to the factory coating** or the **closing of cable outlets** from the field-joint coating are applications for which this product is often used. DENSOLEN®-Mastic can also be used to fill defects in the factory or field-joint coating. The defect area is closed permanently and reliability after the subsequent encasement with a DENSOLEN® tape system.

DENSOLEN®-Mastic is available in **different plasticity grades** and practical **customizations in bar and tape form**.

The use of **DENSOLEN®-HT Primer** is recommended for an optimal adhesion to the pipe surface.

To adapt longer transverse welding seams or spiral welding seams, the adaptation can be performed alternatively with a soft DENSOLEN® tape, e.g. **DENSOLEN®-N15**.

Typical product properties (Excerpt*)

Property	Unit	Typical value		
		DENSOLEN®-W	DENSOLEN®-WP	DENSOLEN®-W+
Density	g/cm³	> 1.4	> 1.4	> 1.7
Consistency		soft, easily formable	good form stability	high stability
Saponification number	mg(KOH)/g	< 10	< 10	< 10
Operating temperature	°C (°F)	-10 to +50 (+14 to +122)	-10 to +50 (+14 to +122)	-10 to +50 (+14 to +122)

* For further product information as well as details on ordering and packaging, please refer to the product data sheet at denso-group.com.

DENSOLEN®-E, DENSOLEN®-N

Self-amalgamating plastic tapes on the basis of butyl rubber for the corrosion prevention and the electrical insulation of pipes and metal parts.

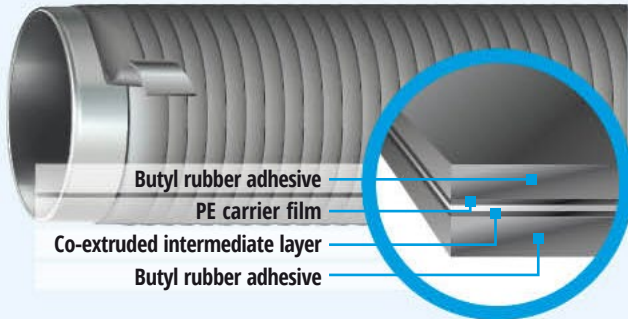

For temperatures from -50°C (-58°F) to +70°C (+158°F).



Can be processed in a cold condition, no flame required.



High flexibility and adaptability.



Fast self-amalgamation.



Electrically highly insulating.



Used in pipeline and plant construction, in chassis and vehicle manufacturing as well as the electrical and telecommunication industry.

DENSOLEN®-E and **DENSOLEN®-N** are plastic tapes that are processed cold. They are butyl rubber based for permanent corrosion prevention encasements and electrical insulations.

The DENSOLEN®-E/-N tapes **grow together in the overlapping** area to a hose-type encasement, which is basically **impermeable against water and oxygen** and it is **electrically highly insulating**.

All DENSOLEN®-E/-N tapes include a polyethylene carrier film, which prevents an overstretching of the tapes during wrapping. Due to its flexibility and adaptability, the DENSOLEN®-E/-N tapes adapt especially well to the substrate structure.

Based on these properties, the DENSOLEN®-E/-N tapes are used in many application areas:

- Corrosion prevention encasement of metallic pipelines at welding connections, containers and systems.
- Corrosion prevention coating for press fitting systems.
- Galvanic isolation at the connection of metals to prevent contact corrosion.

- Sealing of rivet and screw connections in chassis and vehicle manufacture.
- Insulation and sealing of sleeve necks for cable glands in cable sleeves.
- Cable glands at boxes, housings and cabinets.
- Roof inserts of electrical and phone cables and antenna masts.

The colors of the DENSOLEN®-E/-N tapes are different (grey or black) and they are available in several tape thicknesses (overview see table).

The use of **DENSOLEN®-HT Primer** is recommended to improve the adhesive strength to the surface.

DENSOLEN®-E/-N tapes are processed with a slight tension wrapped in spirals. The overlap for this application is normally 50% of the tape width.

In addition, DENSOLEN®-E/-N tapes can be equipped with an outer wrapping made from a two-layer tape, e.g. **DENSOLEN®-PE3**, **DENSOLEN®-PE5** or **DENSOLEN®-R20 HT**. The outer resistant polyethylene carrier film of these tapes results in a significantly increased mechanical strength of the coating.

Typical product properties (Excerpt*)

Product name	Unit	Tape thickness	Color
DENSOLEN®-N8	mm	0.8	grey
DENSOLEN®-N10	mm	1.0	grey
DENSOLEN®-N12	mm	1.2	grey
DENSOLEN®-N15	mm	1.5	grey
DENSOLEN®-E10	mm	1.0	black
DENSOLEN®-E12	mm	1.2	black
DENSOLEN®-E15	mm	1.5	black

Property	Unit	Typical value		Test method
		DENSOLEN®-N10	DENSOLEN®-E10	
Tape thickness	mm	≥ 1.0	≥ 1.0	ISO 4591
Thick carrier film	µm	70	25	ISO 4591
Elongation at break	%	500	200	DIN 30672
Tensile strength	N / mm ²	3	0.75	DIN 53515
Dielectric strength	kV / mm	40	40	DIN 53481
Operating temperature	°C (°F)	-40 to +50 (-40 to +122)		

* For further product information as well as details on ordering and packaging, please refer to the product data sheet at denso-group.com.

DENSOLEN®-AS39 P

Single tape system for the corrosion prevention coating of metal pipes and pipelines in accordance with DIN 30672, EN 12068, ASTM and AWWA. Corrosion prevention system proven for decades – for high mechanical and corrosive stresses.

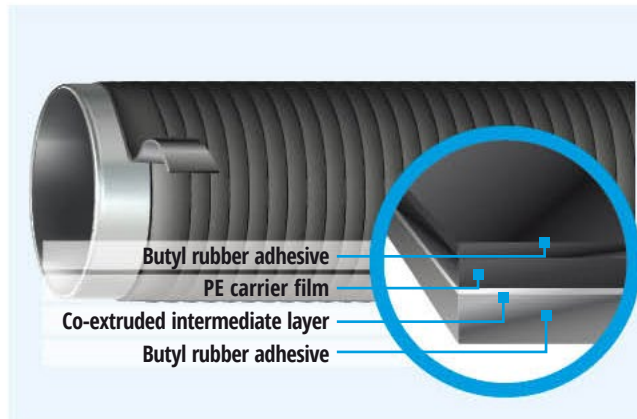

For temperatures from -50°C (-58°F) to +85°C (+185°F).



Fulfills EN 12068-C50 and DIN 30672-C50.



Fulfills ISO 21809-3, Type 12A-1.



Real co-extruded 3-ply tape.



Easy processing through adaptable and highly tear-resistant carrier film.



Compatible with factory coatings made of PE, PP, FBE, PU, CTE and bitumen.

DENSOLEN®-AS39 P is a cold applied single tape system for the corrosion prevention of metal pipes and pipelines in a high mechanical and corrosive stress classes.

With its outstanding properties, DENSOLEN®-AS39 P is the proven corrosion prevention technology for cold applied corrosion prevention tapes since 1972. Due to the innovative formula, the tapes grow completely together in the overlapping area and create a **long-lasting hose-type coating**.

DENSOLEN®-AS39 P is basically impermeable for water vapor and oxygen and it is resistant against soil bacteria and electrolytes.

DENSOLEN®-AS39 P is compatible with factory coatings made of PE, PP, FBE, PU, CTE and Bitumen.

The system DENSOLEN®-AS39 P consists of:

DENSOLEN®-HT Primer

A solvent containing primer in accordance with EN 12068 and DIN 30672 for the corrosion prevention with DENSOLEN® tapes. Please refer to the separate product information of the DENSOLEN®-HT Primer.

DENSOLEN®-AS39 P

A real **co-extruded 3-ply plastic tape** made from stabilized polyethylene carrier materials with butyl rubber adhesive.

DENSOLEN®-AS39 P has a thickness of ≥ 0.8 mm.

DENSOLEN®-AS39 P fulfills the international standards DIN 30672, EN 12068, ISO 218093, ASTM and AWWA.

Supplementary products:

DENSOLEN®-W and -WP Mastic as permanently plastic formable butyl rubber mastic for the equalization of unevennesses and cavities. DEPROTEC®-DRM PP rockshields made of polypropylene non-woven material for the additional mechanical protection of DENSOLEN® coatings with shock absorbing and load distributing effects.

Typical product properties (Excerpt*)

Property	Unit	DENSOLEN®-AS39 P – Typical value		Test method
Carrier film color	-	black		-
Butyl adhesive color inside	-	grey		-
Butyl adhesive color outside	-	black or yellow		-
Total thickness	mm	≥ 0.8		
Carrier film thickness app.	mm	≥ 0.28		ISO 4591
Inside adhesive layer thickness app.	mm	≥ 0.44		ASTM D1000
Outside adhesive layer thickness app.	mm	≥ 0.08		
Operating temperature	°C (°F)	-40 to +50 (-40 to +122)		-
Elongation at break	%	≥ 600		DIN 30672
Tape strength	(+23°C/+73°F) N/cm	≥ 100		EN 12068
Dielectric strength	kV / mm	≥ 40		DIN 53481

Property	Unit	DENSOLEN®-AS39P – Typical value		Test method
Electrical insulation resistance	$\Omega \text{ m}^2$	$\geq 10^{10}$		EN 12068
Peel resistance		(+23°C/+73°F)	(+50°C/+122°F)	
metal/prime coat/AS39 P	N / cm	≥ 25	≥ 2.5	EN 12068
		≥ 33	≥ 2.5	ASTM D1000
Peel resistance layer to layer		(+23°C/+73°F)	(+50°C/+122°F)	
AS39P / AS39P	N / cm	≥ 30	≥ 4	EN 12068
Indentation resistance - residual layer thickness at stamp load: (Stamp-Ø 1.80 mm – four-layer)	mm / N/mm ²	$\geq 0.8 / 10$ (fulfills class C)		EN 12068
Impact resistance (4 layer)	J	≥ 15 (class C)		EN 12068
Cathodic disbondment resistance	mm	≤ 6		ASTM G8
Lap shear strength		(+23°C/+73°F)		
on steel	N / cm ²	≥ 15		EN 12068
on factory coating		≥ 15		

* For further product information as well as details on ordering and packaging, please refer to the product data sheet at denso-group.com.

DENSOLEN®-AS40 Plus

Single tape system for the corrosion prevention coating of metal pipes and pipelines in accordance with DIN 30672, EN 12068, ASTM and AWWA. Corrosion prevention system proven for decades – for high mechanical and corrosive stresses.

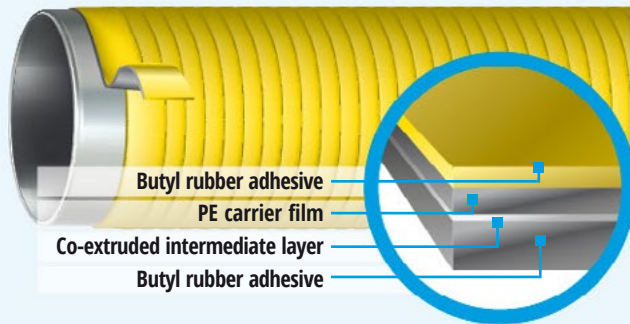

For temperatures from -50°C (-58°F) to +85°C (+185°F).



DIN-DVGW approved system: B 50 and C 50 (EN 12068, DIN 30672).



Fulfills the requirements of ISO 21809-3; Type 12A-1.



Real co-extruded 3-ply tape.



Easy processing through adaptable and highly tear-resistant carrier film.



Compatible with factory coatings made of PE, PP, FBE, PU, CTE and bitumen.

Single tape system for the corrosion prevention of metal pipes and pipelines in high mechanical and corrosive stress classes.

With its outstanding properties, DENSOLEN®-AS40 Plus is the proven corrosion prevention technology for cold applied corrosion prevention tapes since 1972. Due to the innovative formula, the tapes grow completely together in the overlapping area and create a **long-lasting hose-type coating**.

DENSOLEN®-AS40 Plus is a system approved by DIN-DVGW and it can be processed, depending on the protection class, three-layer (B 50) or four-layer (C 50).

DENSOLEN®-AS40 Plus is basically impermeable for water vapor and oxygen and it is resistant against soil bacteria and electrolytes.

DENSOLEN®-AS40 Plus is compatible with factory coatings made of PE, PP, FBE, PU, CTE and Bitumen.

The system DENSOLEN®-AS40 Plus consists of:

DENSOLEN®-HT Primer

A solvent containing primer in accordance with EN 12068 and DIN 30672 for the corrosion prevention with **DENSOLEN®** tapes. Please refer to the separate product information of the DENSOLEN®-HT.

DENSOLEN®-AS40 Plus

A real **co-extruded 3-ply plastic tape** made from stabilized polyethylene carrier film with butyl rubber adhesive.

DENSOLEN®-AS40 Plus fulfills the international standards DIN 30672, EN 12068, ASTM and AWWA.

Supplementary products:

DENSOLEN®-W and **-WP Mastic** as permanently plastic formable butyl rubber mastic for the equalization of unevennesses and cavities.

DEPROTEC®-DRM PP rockshields and **rockshield hose** made of polypropylene non-woven material for the additional mechanical protection of DENSOLEN® coatings with shock absorbing and load distributing effects.

Typical product properties (Excerpt*)

Property	Unit	DENSOLEN®-AS40 Plus – Typical value		Test method
Carrier film color	-	black		-
Butyl adhesive color inside	-	grey		-
Butyl adhesive color outside	-	black or yellow		-
Total thickness	mm	≥ 0.8		-
Carrier film thickness app.	mm	≥ 0.28		ISO 4591
Inside adhesive layer thickness app.	mm	≥ 0.44		ASTM D1000
Outside adhesive layer thickness app.	mm	≥ 0.08		-
Operating temperature	°C (°F)	-40 to +50 (-40 to +122)		-
Elongation at break	%	≥ 600		DIN 30672
Tape strength	(+23°C/+73°F) N/cm	≥ 100		EN 12068
Dielectric strength	kV / mm	≥ 40		DIN 53481

Property	Unit	DENSOLEN®-System AS40 Plus – Typical value		Test method
Specific electrical insulation resistance	Ω m ²	≥ 10 ¹⁰		EN 12068
Peel resistance		(+23°C/+73°F)	(+50°C/+122°F)	
metal/prime coat/AS40 Plus	N / cm	≥ 25	≥ 2.5	EN 12068
		≥ 33	≥ 2.5	ASTM D1000
Peel resistance layer to layer		(+23°C/+73°F)	(+50°C/+122°F)	
AS40 Plus / AS40 Plus	N / cm	≥ 30	≥ 4	EN 12068
Indentation resistance - residual layer thickness at stamp load:		(±50°C/±122°F)		
4 layer (Stamp-Ø 1.80 mm – 4-layer)	mm / N/mm ²	≥ 0.8 (fulfills class C)		EN 12068
3 layers (Stamp-Ø 5.65 mm – 3-layer)		≥ 0.8 (fulfills class B)		
Impact resistance (4-layer)/(3-layer)	J	≥ 15 (class C) / ≥ 10 (class B)		EN 12068
Cathodic disbondment resistance	mm	≤ 6		ASTM G8
Lap shear strength		(±23°C/±73°F)		
on steel		≥ 15		
on factory coating	N / cm ²	≥ 15		EN 12068

* For further product information as well as details on ordering and packaging, please refer to the product data sheet at denso-group.com.

DENSOLEN®-AS40 HT

Single tape system resistant to high temperatures for lasting corrosion prevention for metal pipes and pipelines, particularly at operating temperatures up to +100°C (+212°F).

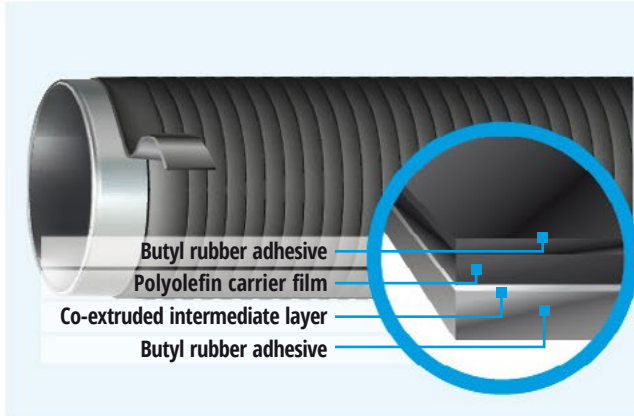

For temperatures from -50°C (-58°F) to +100°C (+212°F).



Fulfills EN 12068-C80 and DIN 30672-C80.



Fulfills ISO 21809-3; Type 12A-3.



Fulfills ISO 21809-3 at **+100°C (+212°F)**, in a **2-layer application with just one wrapping process**.



Excellent shear strength even at maximum operating temperature.



Cost-effective use by hand or with DENSOMAT® wrapping devices.

DENSOLEN®-AS40 HT sets a new benchmark as a **single tape system** suitable for cold processing and resistant to high temperatures. A patent provides the impressive testament to the product's unique composition.

Thanks to the innovative formula, the tapes fuse together completely in the overlap area and create a long-lasting hose-type coating.

DENSOLEN®-AS40 HT has **outstanding properties**, particularly in combination with the primer specially formulated to resist higher temperatures, **DENSOLEN®-HT100 Primer**.

Just **one wrapping process** with 50% overlap **suffices** to fulfil the requirements of ISO 21809-3.

With a 4-layer application, you can further **increase the effect of the properties significantly**.

Even at the **maximum operating temperature** you will obtain **excellent shear strength**, regardless of the number of layers you have selected.

The outstanding economic and qualitative properties of DENSOLEN®-AS40 HT allow you to achieve a **cost-efficient coating**.

DENSOLEN®-AS40 HT is impermeable against water vapour and oxygen and it is resistant against soil bacteria and soil electrolytes.

As a **genuine, co-extruded 3-layer plastic tape**, it has an **excellent bond between adhesive and carrier film**. It consists of stabilised polyolefin carrier material with a butyl rubber adhesive on both sides.

DENSOLEN®-AS40 HT is compatible with factory coatings made of PE, PP, FBE, PU and bitumen.

DENSIT®-AL and **DENSIT®-PB** are other products available to you for use **above ground**: they are also visually appealing and reduce the UV strain.

Typical product properties (Excerpt*)

Property	Unit	Typical value	Test method
Outside colour	-	Black	-
Inside colour	-	grey	-
Total thickness	mm	≥ 0.8	
Outer adhesive layer thickness	mm	≥ 0.08	
Carrier film thickness	mm	≥ 0.28	ISO 4591
Inside adhesive layer thickness	mm	≥ 0.44	ASTM D1000
Operating temperature	°C (°F)	-40°C (-40°F) to +100°C (+212°F)	
Elongation at break	%	600	EN 12068
Tape strength (+23°C/+73°F)	N/cm	100	EN 12068
Dielectric strength	kV / mm	≥ 40	DIN 53481

Property	Test temperature	Unit	Typical value		Test Standard
			2-layer	4-layer	
Impact resistance	+23°C (+73°F)	J/mm	≥ 4.3	≥ 6.0	ISO 21809-3
Indentation resistance (residual layer thickness)	+23°C (+73°F)	mm	≥ 0.9	≥ 2.0	
	+100°C (+212°F)		≥ 0.6	≥ 1.3	
Cathodic disbondment resistance (28 days)	+23°C (+73°F)	mm	≤ 5		
Peel strength (inner layer/inner layer) (inner layer/outer layer) (Außenlage/Außenlage)	+23°C (+73°F)	N/cm	≥ 35		
	+23°C (+73°F)	N/cm	≥ 18		
Schälwiderstand (steel surface)	+23°C (+73°F)	N/cm	≥ 18		
Lap shear strength	+23°C (+73°F)	N/cm ²	≥ 20		
	+100°C (+212°F)		≥ 4		

* For further product information as well as details on ordering and packaging, please refer to the product data sheet at denso-group.com.

DENSOLEN®-AS50

Single tape system for outstanding corrosion prevention of metal pipes and pipelines in accordance with DIN 30672, EN 12068, ASTM and AWWA. For extreme corrosion conditions and mechanical stresses.

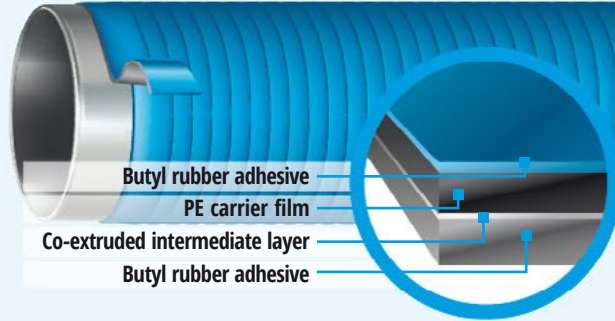

For temperatures from -50°C (-58°F) to +85°C (+185°F).



Fulfills EN 12068-B50 and DIN 30672-B50



Fulfills class B 50 in accordance with EN 12068, already with one wrapping with 50% overlapping.



Fulfills ISO 21809-3; Type 12A-1.



Extremely cost efficient and easy application.



Especially qualified for the requirements of the water pipe construction.

Single tape system for outstanding corrosion prevention of metal pipes with outstanding economic and qualitative properties.

Due to the innovative formula, the tapes grow completely together in the overlapping area and create a **long-lasting hose-type coating**.

DENSOLEN®-AS50 significantly **exceeds the requirements** of the stress class **B 50** in accordance with EN 12068 and DIN 30672, using **only one wrapping** process with 50% overlap.

The DENSOLEN®-AS50 is basically impermeable against water vapor and oxygen and it is resistant against soil bacteria and soil electrolytes.

DENSOLEN®-AS50 is compatible with factory coatings made from PE, PP, FBE, PU and bitumen.

The system DENSOLEN®-AS50 consists of:

DENSOLEN®-HT Primer

A solvent containing prime coat in accordance with EN 12068 and DIN 30672 for corrosion prevention with **DENSOLEN®** tapes. Please refer to the separate product information of the DENSOLEN®-HT Primer.

DENSOLEN®-AS50

A real **co-extruded 3-ply plastic tape** made from stabilized polyethylene carrier materials with butyl rubber adhesive on both sides.

Due to its intermediate layer, DENSOLEN®-AS50 features an outstanding connection between adhesive and carrier film.

DENSOLEN®-AS50 fulfills the international standards DIN 30672, EN 12068, ASTM and AWWA.

Typical product properties (Excerpt*)

Property	Unit	DENSOLEN®-AS50 – Typical value		Test method
Carrier film color	-	black		-
Butyl adhesive color inside	-	grey		-
Butyl adhesive color outside	-	black, blue		-
Total thickness	mm	≥ 1.1		-
Carrier film thickness app.	mm	≥ 0.6		ISO 4591
Inside adhesive layer thickness app.	mm	≥ 0.5		ASTM D1000
Outside adhesive layer thickness app.	mm	≥ 0.08		-
Operating temperature	°C (°F)	-40 to +50 (-40 to +122)		-
Elongation at break	%	≥ 550		DIN 30672
Tape strength	(+23°C/+73°F) N/cm	≥ 95		EN 12068
Dielectric strength	kV / mm	≥ 40		DIN 53481

Property	Unit	DENSOLEN®-System AS50 – Typical value		Test method
Specific electrical insulation resistance	Ω m²	≥ 10 ¹⁰		EN 12068
Peel resistance		(+23°C/+73°F)	(+50°C/+122°F)	
metal / prime coat / AS50	N / cm	≥ 30	≥ 2.5	EN 12068
		≥ 33	≥ 2.5	ASTM D1000
Peel resistance layer to layer		(+23°C/+73°F)	(+50°C/+122°F)	
AS50 / AS50	N / cm	≥ 30	≥ 4	EN 12068
Indentation resistance - residual layer thickness at stamp load (10 N/mm² Stamp-diameter 5,65 mm)	mm / N/mm²	(±50°C/±122°F) > 0.8mm		EN 12068
Impact resistance	J	≥ 10		EN 12068
Cathodic disbondment resistance	mm	≤ 6		ASTM G8
Lap shear strength		(±23°C/±73°F)		
on steel		≥ 15		
on factory coating	N / cm²	≥ 15		EN 12068

* For further product information as well as details on ordering and packaging, please refer to the product data sheet at denso-group.com.

DENSOLEN®-S10

Single tape system for the corrosion prevention coating of metal pipes, pipelines and containers in accordance with DIN 30672, EN 12068, ASTM and AWWA. For extreme corrosion conditions and mechanical stresses on uneven substrates.

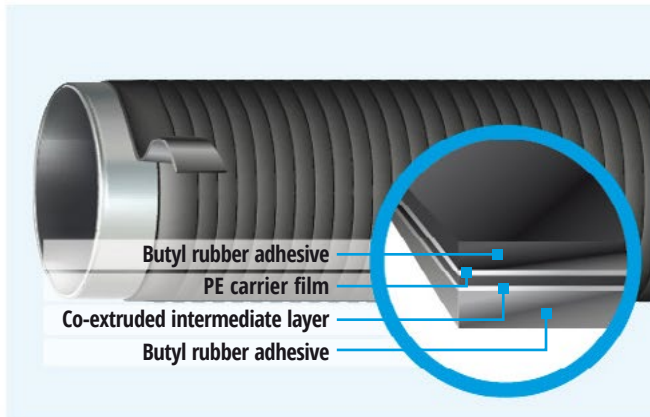

- For temperatures from -50°C (-58°F) to +70°C (+158°F).
- Co-extruded 3-ply tape with an especially adapting carrier film.
- Single tape system for flanges, T-fit-tings and other fittings.
- Fulfills EN 12068-B50 and DIN 30672-B50.
- Tested in accordance with ASTM.

DENSOLEN®-S10 is a cold applied single tape system for corrosion prevention of metal pipes, pipelines and fittings. It is **especially suitable for uneven substrates and complicated geometries**.

An especially adaptable carrier film makes it possible that DENSOLEN®-S10 adapts perfectly to uneven surfaces and parts that are formed with a complicated shape.

Due to the innovative formula, the tapes grow completely together in the overlapping area and create a **long-lasting hose-type coating**.

DENSOLEN®-S10 is a system approved by DIN-DVGW (B 50) with an **impact resistance** that is equivalent to **class C**.

DENSOLEN®-S10 is basically impermeable for water vapor and oxygen and it is resistant against soil bacteria and electrolytes.

DENSOLEN®-S10 is compatible with factory coatings made of PE, PP, FBE, PU, CTE and Bitumen.

The system DENSOLEN®-S10 consists of:

DENSOLEN®-HT Primer

a solvent containing primer, which provides an optimal adhesion of the **DENSOLEN®** tapes with the substrate.

Please refer to the separate product information of the DENSOLEN®-HT Primer.

DENSOLEN®-S10, a **co-extruded 3-ply plastic tape** made from stabilized polyethylene carrier materials with butyl rubber adhesive on both sides.

Typical product properties (Excerpt*)

Property	Unit	DENSOLEN®-S10 – Typical value		Test method
Carrier film color	-	black		-
Butyl adhesive color inside	-	grey		-
Butyl adhesive color outside	-	black		-
Total thickness	mm	≥ 0.8		-
Carrier film thickness app.	mm	≥ 0.14		ISO 4591
Inside adhesive layer thickness app.	mm	≥ 0.38		ASTM D1000
Outside adhesive layer thickness app.	mm	≥ 0.28		-
Operating temperature	°C (°F)	-40 to +50 (-40 to +122)		-
Elongation at break	%	≥ 250		DIN 30672
Tape strength	(+23°C/+73°F) N/cm	≥ 40		EN 12068
Dielectric strength	kV / mm	≥ 10		DIN 53481

Property	Unit	Typical value		Test method
Specific electrical insulation resistance	Ω m²	≥ 10 ¹⁰		EN 12068
Peel resistance		(+23°C/+73°F)	(+50°C/+122°F)	
		metal / primer / S10	N / cm	≥ 20 ≥ 35
Peel resistance layer to layer		(+23°C/+73°F)	(+50°C/+122°F)	
		S10 / S10	N / cm	≥ 25
Indentation resistance	(+50°C/+122°F) mm	> 0.8mm		EN 12068
Impact resistance (four-layer)	J	≥ 15 (fulfills class C)		EN 12068
Cathodic disbondment resistance	mm	≤ 8		ASTM G8
Lap shear strength (+23°C/+73°F)	on steel	≥ 15		EN 12068
	on PE	≥ 15		
Systems building	Primer	DENSOLEN®-HT		
	Tape			

* For further product information as well as details on ordering and packaging, please refer to the product data sheet at denso-group.com.

DENSOLEN®-AS30/-R20 MP

Two-tape system for the corrosion prevention coating of metal pipes and pipelines in accordance with DIN 30672 and EN 12068.

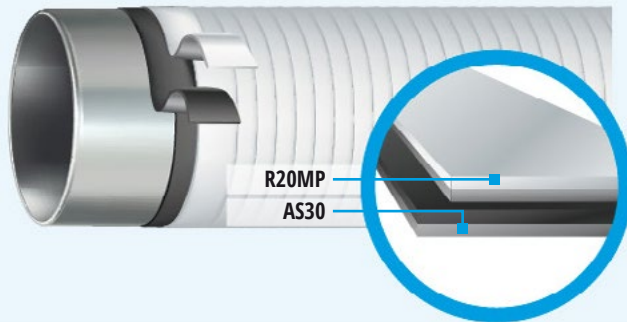

For temperatures from -50°C (-58°F) to +70°C (+158°F).



No spiral corrosion hazard as compared to a two-ply tape.



Fulfills EN 12068-B50.



Fulfills ISO 21809-3, Type 12A-1.



Compatible with factory coatings made of PE, PP, FBE, PU, CTE and bitumen.



Outstanding tape elasticity and elongation at break.



Cost-effective system with outstanding price/performance ratio.

DENSOLEN®-AS30/-R20 MP is a cold applied tape system for corrosion prevention of metal pipes and pipelines with outstanding economic and qualitative properties. Due to the innovative formula, the tapes grow completely together in the overlapping area and create a **long-lasting hose-type encasement**.

DENSOLEN®-AS30/-R20 MP fulfills the requirements of the impact resistance of class B 50 in accordance with EN 12068 and **even the indentation resistance of class C 50**. DENSOLEN®-AS30/-R20 MP is basically impermeable for water vapor and oxygen and it is resistant against soil bacteria and electrolytes. DENSOLEN®-AS30/-R20 MP is compatible with factory coatings made of PE, PP, FBE, PU, CTE und Bitumen.

The system **DENSOLEN®-AS30/-R20 MP** consists of:

DENSOLEN®-HT Primer

A solvent containing primer for corrosion prevention in combination with DENSOLEN® tapes. For the processing in hot environments, the DENSOLEN®-MT25 Primer can

be used as an alternative. Please refer to the separate product data sheet DENSOLEN®-Primer.

DENSOLEN®-AS30

A real **co-extruded 3-ply plastic tape** made from stabilized polyethylene carrier materials with butyl rubber adhesive on both sides. DENSOLEN®-AS30 grows completely together in the overlapping area and creates a hose-type encasement, which results in a reliable and durable corrosion protection. An outstanding connection between the adhesive and the carrier film is guaranteed by the co-extruded intermediate layer.

DENSOLEN®-R20 MP

A **co-extruded two-layer plastic tape** made from robust white polyethylene carrier film with a single side butyl rubber coating. An outstanding connection between the adhesive and the carrier film is achieved by the co-extruded intermediate layer. The butyl rubber adhesive layer grows completely together with the outside layer of DENSOLEN®-AS30.

Typical product properties (Excerpt*)

Property	Unit	DENSOLEN®-AS30 – Typical value	DENSOLEN®-R20MP – Typical value	Test method
Carrier film color	-	black	white	-
Butyl adhesive color inside	-	grey	black	-
Butyl adhesive color outside	-	black	-	-
Total thickness	mm	≥ 0.5	≥ 0.5	-
Carrier film thickness app.	mm	≥ 0.18	≥ 0.3	ISO 4591
Inside adhesive layer thickness app.	mm	≥ 0.24	≥ 0.2	ASTM D1000
Outside adhesive layer thickness app.	mm	≥ 0.08	-	-
Operating temperatur	°C (°F)	-50 to +70 (-58 to +158)		-
Elongation at break	%	≥ 600	≥ 500	DIN 30672
Tensile strength (+23°C/+73°F)	N/cm	≥ 65	≥ 65	EN 12068
Dielectric strength	kV / mm	≥ 40	≥ 50	ASTM D149

DENSOLEN®-AS30/-R20 MP with DENSOLEN®-HT Primer

Property	Unit	Typical value		Test method
Specific electrical insulation resistance	Ω m²	≥ 10 ¹¹		EN 12068
Peel resistance		(+23°C/+73°F)	(+50°C/+122°F)	
metal/primer/tape	N / cm	≥ 15	≥ 2.0	EN 12068
		≥ 33	≥ 2.5	ASTM D1000
Peel resistance layer to layer		(+23°C/+73°F)	(+50°C/+122°F)	
AS30 / AS30		≥ 22	≥ 4.0	
AS30 / R20 MP	N / cm	≥ 22	≥ 3.5	EN 12068
R20 MP / R20 MP		≥ 4	≥ 3.5	
Indentation resistance - residual layer thickness		(50°C/+122°F)		
for stamp load 1N / mm², stamp-Ø 5.65 mm	mm	> 1.3 (fulfills class B)		EN 12068
for stamp load 10 N / mm², stamp-Ø 1.8 mm		> 0.6 (fulfills class C)		
Impact resistance	J	≥ 10		EN 12068
Cathodic disbondment resistance (radius)	mm	< 2		EN 12068
Lap shear strength		(23°C/+73°F)		
on steel		≥ 8		
on factory coating	N / cm²	≥ 8		EN 12068

* For further product information as well as details on ordering and packaging, please refer to the product data sheet at denso-group.com.

DENSOLEN®-AS39 P/-R20 HT

Two-tape system for the corrosion prevention coating of metal pipes and pipelines in accordance with DIN 30672, EN 12068 and ASTM. For extreme corrosion conditions and extreme mechanical stresses – corrosion prevention system with a proven success rate of many thousand kilometers pipeline construction and rehabilitation worldwide.

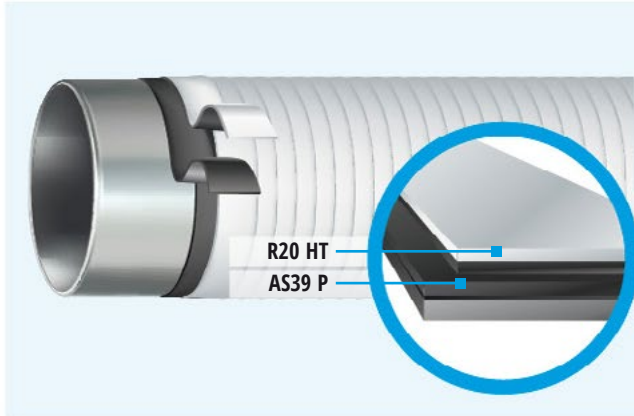

For temperatures from -50°C (-58°F) to +85°C (+185°F).



Excellent mechanical protection and excellent corrosion prevention.



Fulfills the requirements of EN 12068-C50 and DIN 30672-C50



Fulfills the requirements of ISO 21809-3; Type 12A-1.



Real co-extruded three-ply tape as the inner layer and two-layer tape as the outer layer.



Compatible with factory coatings made of PE, PP, FBE, PU, CTE and bitumen.

DENSOLEN®-AS39 P/-R20 HT is a cold applied two-tape system for the corrosion prevention of metal pipes and pipelines in extreme corrosion conditions and mechanical stresses.

Due to the innovative formula, the tapes grow completely together in the overlapping area and create a long-lasting hose-type coating.

DENSOLEN®-AS39 P/-R20 HT has proven itself in a multitude of construction projects and has **many approvals of pipeline network operators** such as Indian Oil Corporation Ltd.

DENSOLEN®-AS39 P/-R20 HT is basically impermeable for water vapor and oxygen and it is resistant against soil bacteria and electrolytes.

DENSOLEN®-AS39 P/-R20 HT is compatible with factory coatings made of PE, PP, FBE, PU, CTE and Bitumen.

The system **DENSOLEN®-AS39 P/-R20 HT** consists of:

DENSOLEN®-HT Primer

A solvent containing primer in accordance with EN 12068 and DIN 30672 for the corrosion prevention in combination with **DENSOLEN®** tapes. For the processing in hot environments.

DENSOLEN®-AS39 P.

A real **co-extruded 3-ply plastic tape** made from stabilized polyethylene carrier materials with butyl rubber adhesive on both sides.

DENSOLEN®-R20 HT

A real **co-extruded two-layer plastic tape** made from stabilized polyethylene carrier film with a butyl rubber adhesive on one side. The outstanding connection between the adhesive and the carrier film is guaranteed by the co-extruded intermediate layer. The adhesive layer grows completely together with the outside layer DENSOLEN®-AS39 P.

Typical product properties (Excerpt*)

Property	Unit	DENSOLEN®-AS39 P – Typical value	DENSOLEN®-R20 HT – Typical value	Test method
Carrier film color	-	black	white, black or blue	-
Butyl adhesive color inside	-	grey	black	-
Butyl adhesive color outside	-	black	-	-
Total thickness	mm	≥ 0.8	≥ 0.5	
Carrier film thickness app.	mm	≥ 0.28	≥ 0.3	ISO 4591
Inside adhesive layer thickness app.	mm	≥ 0.44	≥ 0.2	ASTM D1000
Outside adhesive layer thickness app.	mm	≥ 0.08	-	
Operating temperatur	°C (°F)		-40 to +50 (-40 to +122)	-
Elongation at break	%	≥ 600	≥ 550	DIN 30672
Tape strength	(+23°C/+73°F) N/cm	≥ 100	≥ 65	EN 12068
Dielectric strength	kV / mm	≥ 40	≥ 35	DIN 53481

DENSOLEN®-AS39 P/-R20 HT mit DENSOLEN®-HT Primer

Property	Unit	DENSOLEN®-AS39 P/-R20 HT – Typical value		Test method
Electrical insulation resistance	Ω m²	≥ 10 ¹⁰		EN 12068
Peel resistance		(+23°C/+73°F)	(+50°C/+122°F)	
metal/primer/tape	N / cm	≥ 25	≥ 3	EN 12068
		≥ 45	≥ 5	ASTM D1000
Peel resistance layer to layer		(+23°C/+73°F)	(+50°C/+122°F)	
AS39P / AS39P		≥ 30	≥ 4	
AS39P / R20HT	N / cm	≥ 30	≥ 3	EN 12068
R20HT / R20HT		≥ 3	≥ 3	
Indentation resistance - residual layer thickness at stamp load 10 N / mm² (stamp-Ø 1.8 mm)	mm	(±50°C/±122°F)		EN 12068
		≥ 1.1		
Impact resistance	J	≥ 16		EN 12068
Cathodic disbondment resistance	mm	< 6		EN 12068
Lap shear strength		(±23°C/±73°F)		
on steel	N / cm²	≥ 15		EN 12068
on factory coating		≥ 15		

*** For further product information as well as details on ordering and packaging, please refer to the product data sheet at denso-group.com.**

DENSOLEN®-AS40 Plus/-090

Two-tape system for the field-joint coating of pipelines especially gas pipe networks.

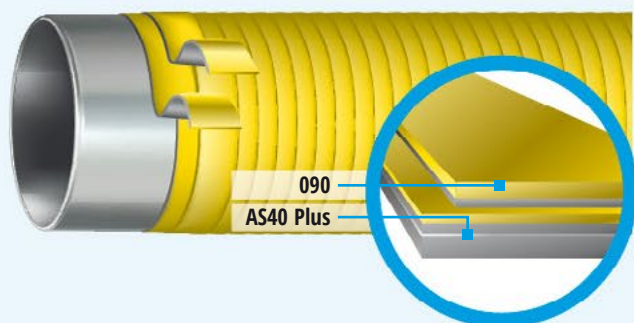

For temperatures from -50°C (-58°F) to +85°C (+185°F).



Approval by GRTgaz (FR) for stress class HR (RV02).



Fulfills stress class B 50 in accordance with EN 12068.



Compatible with factory coatings made of PE, PP, FBE, PUR and bitumen.



Ideal for corrosion prevention in gas pipe networks.

DENSOLEN®-AS40 Plus/-090 is a tape system for the permanent corrosion prevention for buried pipelines.

DENSOLEN®-AS40 Plus/-090 is outstandingly qualified for the **use on pipes with smaller nominal pipe sizes**. The yellow color of the outside tape is adapted to the use in gas pipe networks.

DENSOLEN®-AS40 Plus/-090 fulfills the requirements for stress class B 50 in accordance with EN 12068. In addition DENSOLEN®-AS40 Plus/-090 fulfills the requirements for stress class HR of the specification RV02 by GRTgaz (France) (certificate No. 106).

Standard designation:

- EN 12068 – B 50



DENSOLEN®-AS40 Plus as inside tape, fulfills essentially the corrosion prevention of the encasement system.

DENSOLEN®-AS40 Plus is a **co-ex-truded 3-ply tape** with a two-sided asymmetrical butyl rubber coating.

This 3-ply design establishes an essentially gas and water type encasement in the overlapping area of the tape through self-amalgamation of the upper and lower butyl rubber coating.

DENSOLEN®-090 is used as the outside tape in the encasement system and provides the mechanical protection of the inside tape. DENSOLEN®-090 is a flexible two-layer tape with a polyethylene outside layer and an inside butyl rubber coating, which welds together with the outside layer of the inside tape. Both DENSOLEN® tapes can be processed efficiently with the **DENSOMAT® wrapping devices**.

Typical product properties (Excerpt*)

Property	Unit	DENSOLEN®-AS40 Plus – Typical value	DENSOLEN®-090 – Typical value	Test method
Carrier film color	-	black	yellow	-
Butyl adhesive color inside	-	grey	grey	-
Butyl adhesive color outside	-	black	-	-
Tape thickness	mm	≥ 0.8	≥ 0.4	-
Carrier film thickness app.	mm	≥ 0.28	≥ 0.26	ISO 4591
Inside adhesive layer thickness app.	mm	≥ 0.44	≥ 0.14	ASTM D1000
Outside adhesive layer thickness app.	mm	≥ 0.08	-	-
Operating temperature	°C (°F)	-40 to +50 (-40 to +122)		-
Elongation at break	%	≥ 600	≥ 400	DIN 30672
Tape strength	N/cm	≥ 100	≥ 35	EN 12068
Electric strength	kV / mm	≥ 40	-	ASTM D149

DENSOLEN®-AS40 Plus/-090 mit DENSOLEN®-HT Primer

Property	Unit	Typical value	Test method
Specific electrical insulation resistance	Ω m ²	≥ 10 ¹⁰	EN 12068
Peel strength on steel	Steel (+23°C/+73°F)	≥ 25	EN 12068
	Steel (+50°C/+122°F)	≥ 2,5	EN 12068
Peel resistance layer to layer	AS40 Plus / AS40 Plus	≥ 30	-
	AS40 Plus / 090	≥ 30	EN 12068
	090 / 090	≥ 2	-
Indentation re-sistance (residual layer thickness)	(+23°C/+73°F) 1N/mm ² , stamp-Ø 5.65mm	mm ≥ 0.6	EN 12068
Impact resistance	J	≥ 16	GdF RV 02
		≥ 10	EN 12068
Cathodic disbondment resistance	mm	< 6	EN 12068
Lap shear strength	on steel	≥ 15	EN 12068
	on PE	≥ 15	

* For further product information as well as details on ordering and packaging, please refer to the product data sheet at denso-group.com.

DENSOLEN®-AS40 Plus/-R20 HT

Two-tape system for the corrosion prevention coating of metal pipes and pipelines in accordance with DIN 30672 and EN 12068.

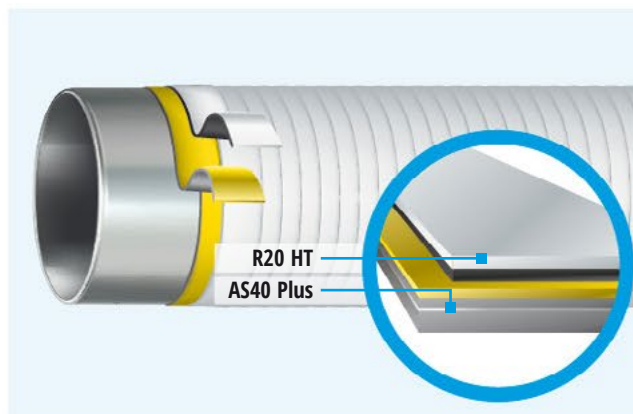

For temperatures from -50°C (-58°F) to +85°C (+185°F).



Excellent mechanical protection and excellent corrosion prevention.



Fulfills the requirements of EN 12068-C50 and DIN 30672-C50



Fulfills the requirements of ISO 21809-3; Type 12A-1.



Real co-extruded three-ply tape as the inner layer and two-layer tape as the outer layer.



Compatible with factory coatings made of PE, PP, FBE, PU, CTE and bitumen.

DENSOLEN®-AS40 Plus/-R20 HT is a cold applied two-tape system for the corrosion prevention of metal pipes and pipelines in extreme corrosion conditions and mechanical stresses. Compared to the single tape system DENSOLEN®-AS40 Plus, a robust and UV resistant surface of the encasement is achieved with the outside tape **DENSOLEN®-R20 HT**.

DENSOLEN®-AS40 Plus/-R20 HT provides a **self-amalgamation of the tapes** in the overlapping area, which means that a tight and durable hose-type encasement is established.

DENSOLEN®-AS40 Plus/-R20 HT is basically impermeable for water vapor and oxygen and it is resistant against soil bacteria and electrolytes.

DENSOLEN®-AS40 Plus/-R20 HT is compatible with factory coatings made of PE, PP, FBE, PU, CTE and Bitumen.

The system DENSOLEN®-AS40 Plus/-R20 HT consists of:

DENSOLEN®-HT Primer

A solvent containing primer in accordance with EN 12068 and DIN 30672 for the corrosion prevention with **DENSOLEN®** tapes.

DENSOLEN®-AS40 Plus

A real **co-extruded 3-ply plastic tape** made from stabilized polyethylene carrier with butyl rubber adhesive on both sides.

DENSOLEN®-R20 HT

A real **co-extruded two-ply plastic tape** made from stabilized polyethylene carrier film with a butyl rubber adhesive on one side.

The outstanding connection between the adhesive and the carrier film is guaranteed by the co-extruded intermediate layer. The adhesive layer grows completely together with the outside layer of DENSOLEN®-AS40 Plus.

Typical product properties (Excerpt*)

Property	Unit	DENSOLEN®-AS40 Plus – Typical value	DENSOLEN®-R20 HT – Typical value	Test method
Carrier film color	-	black, yellow or blue	white, black or blue	-
Butyl adhesive color inside	-	grey	black	-
Butyl adhesive color outside	-	black	-	-
Tape thickness	mm	≥ 0.8	≥ 0.5	ISO 4591 ASTM D1000
Carrier film thickness app.	mm	≥ 0.28	≥ 0.3	
Inside adhesive layer thickness app.	mm	≥ 0.44	≥ 0.2	
Outside adhesive layer thickness app.	mm	≥ 0.08	-	-
Operating temperature	°C (°F)	-40 to +50 (-40 to +122)		-
Elongation at break	%	≥ 600	≥ 500	DIN 30672
Tape strength	(+23°C/+73°F) N/cm	≥ 100	≥ 65	EN 12068

DENSOLEN®-AS40 Plus/-R20 HT with DENSOLEN®-HT Primer

Property	Unit	DENSOLEN®-AS40 Plus/R20 HT – Typical value		Test method
Specific electrical insulation resistance	Ω m²	≥ 10 ¹⁰		EN 12068
Peel resistance		(+23°C/+73°F)	(+50°C/+122°F)	
metal/primer/tape	N / cm	≥ 25	≥ 3	EN 12068
		≥ 45	≥ 5	ASTM D1000
Peel strength layer to layer		(+23°C/+73°F)	(+50°C/+122°F)	
AS50 / AS50		≥ 30	≥ 4	
AS50 / R20 HT	N / cm	≥ 30	≥ 3	EN 12068
R20HT / R20 HT		≥ 3	≥ 3	
Indentation resistance - residual layer thickness at stamp load 10 N/mm² (stamp-Ø 1.8 mm)	mm	(±50°C/±122°F)		EN 12068
		≥ 1.1		
Impact resistance	J	≥ 16		EN 12068
Cathodic disbondment resistance	mm	≤ 6		EN 12068
Lap shear strength		(±23°C/+73°F)		
on steel		≥ 15		
on factory coating	N / cm²	≥ 15		EN 12068

* For further product information as well as details on ordering and packaging, please refer to the product data sheet at denso-group.com.

DENSOLEN®-AS40 Plus/-R25 HT

Two-tape system for the field-joint coating of pipelines, especially in case of very high mechanical stress and large nominal pipe sizes.

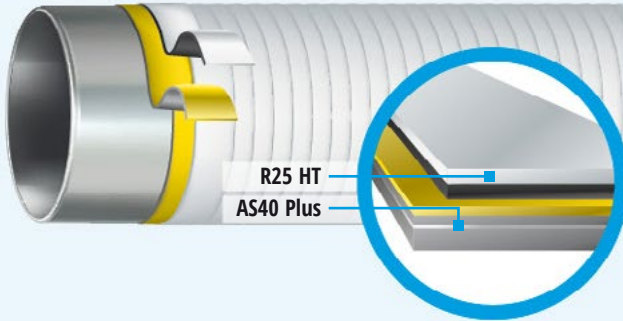

- For temperatures from -50°C (-58°F) to +85°C (+185°F).
- Approval by GRTgaz (FR) for stress class STHR (RV02).
- Fulfills stress class C 50 in accordance with EN 12068.
- Fulfills the requirements of ISO 21809-3; Type 12A-1.
- Proven corrosion prevention with co-extruded three-ply tape.
- Compatible with factory coatings made of PE, PP, FBE, PUR and bitumen.

DENSOLEN®-AS40 Plus/-R25 HT is a coating system for the permanent corrosion prevention of pipelines **satisfying the highest requirements for mechanical stresses and durability**. DENSOLEN®-AS40 Plus/-R25 HT is designed for the field-joint coating or the rehabilitation of corrosion prevention coatings on transport lines, especially for large nominal pipe sizes.

The DENSOLEN®-AS40 Plus/-R25 HT system fulfills the requirements for the stress class C 50 in accordance with EN 12068 and additionally the high requirements for the stress class STHR of the RV02 specification by GRTgaz (France) (certificate No. 214).

Standard designation:

- EN 12068 – C 50

DENSOLEN®-AS40 Plus inside tape, fulfills essentially the corrosion prevention of the encasement system. **DENSOLEN®-AS40 Plus is a co-extruded 3-ply tape.**

This three-layer design establishes an essentially gas and water type encasement in the overlapping area of the tape through self-amalgamation of the upper and lower butyl rubber coating.

DENSOLEN®-R25 HT is a robust two-layer tape consisting of an outside layer made of high density polyethylene and an in inside butyl rubber coating, which grows together with the outside layer of the inside tape.

The high strength polyethylene outside layer and the relative large tape thickness of 0.65 mm **provide an outstanding mechanical protection** of the corrosion prevention encasement.

Both DENSOLEN® tapes can be processed efficiently with the **DENSOMAT® wrapping devices**.

Typical product properties (Excerpt*)

Property	Unit	DENSOLEN®-AS40 Plus – Typical value	DENSOLEN®-R25 HT – Typical value	Test method
Carrier film color	-	black	white, black or blue	-
Butyl adhesive color inside	-	grey	black	-
Butyl adhesive color outside	-	black	-	-
Tape thickness	mm	≥ 0.8	≥ 0.65	ISO 4591 ASTM D1000
Carrier film thickness app.	mm	≥ 0.28	≥ 0.33	
Inside adhesive layer thickness app.	mm	≥ 0.44	≥ 0.32	
Outside adhesive layer thickness app.	mm	≥ 0.08	-	-
Operating temperature	°C (°F)	-40 to +50 (-40 to +122)		-
Elongation at break	%	≥ 600	≥ 450	DIN 30672
Tape strength	N/cm	≥ 100	≥ 65	EN 12068
Dielectric strength	kV / mm	≥ 40	-	ASTM D149

DENSOLEN®-AS40 Plus/-R25 HT with DENSOLEN®-HT Primer

Property	Unit	Typical value	Test method	
Specific electrical insulation resistance	Ω m²	≥ 10 ¹⁰	EN 12068	
Peel strength on steel	Steel (+23°C/+73°F)	≥ 25	EN 12068	
	Steel (+50°C/+122°F)	≥ 2.5	EN 12068	
Peel strength layer to layer	AS40 Plus / AS40 Plus	≥ 30	EN 12068	
	AS40 Plus / R25 HT	≥ 30		
	R25 HT / R25 HT	≥ 3		
Indentation resistance (residual layer thickness)	(+23°C/+73°F) (15 MPa)	mm	≥ 0.6	EN 12068 / RV02
Impact resistance	J		≥ 30	GdF RV 02
			≥ 17	EN 12068
Cathodic disbondment resistance	mm		< 6	EN 12068
Lap shear strength (+23°C/+73°F)	on steel	N / cm²	≥ 15	EN 12068
	on PE		≥ 15	

* For further product information as well as details on ordering and packaging, please refer to the product data sheet at denso-group.com.

DENSOLEN®-AS50/-R20 HT

Two-tape system for the corrosion prevention coating of metal pipes and pipelines in accordance with DIN 30672, EN 12068. For extreme corrosion conditions and extreme mechanical stresses.

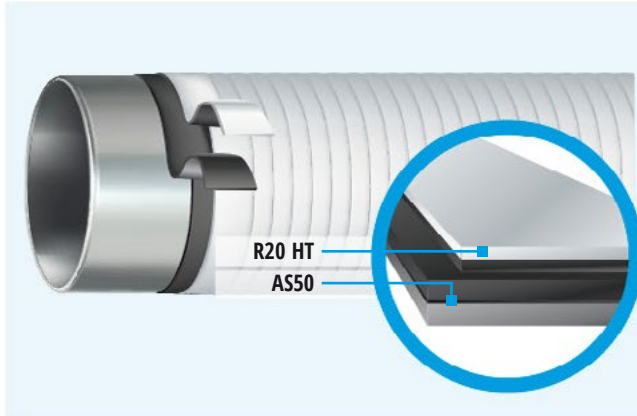

For temperatures from -50°C (-58°F) to $+85^{\circ}\text{C}$ ($+185^{\circ}\text{F}$).



Maximum mechanical protection and maximum corrosion prevention.



Exceeds the requirements of stress class C 50 in accordance with EN 12068.



Fulfills EN 12068-C50 and DIN 30672-C50.



Fulfills the requirements of ISO 21809-3; Type 12A-1.



Compatible with factory coatings made of PE, PP, FBE, PU, CTE and bitumen.

DENSOLEN®-AS50/-R20HT is a cold applied two-tape system for the corrosion prevention of metal pipes and pipelines with outstanding properties.

An **indentation resistance** of ≥ 1.2 mm, which **exceeds** the requirements of ≥ 0.6 mm for stress class C **by 100%** and an **impact resistance of ≥ 20 J** are proof for the uniqueness of this tape system.

DENSOLEN®-AS50/-R20HT is basically impermeable for water vapor and oxygen and it is resistant against soil bacteria and electrolytes.

DENSOLEN®-AS50/-R20HT is compatible with factory coatings made of PE, PP, FBE, PU, CTE and Bitumen.

The system **DENSOLEN®-AS50/-R20 HT** consists of:

DENSOLEN®-HT Primer

A solvent containing primer in accordance with EN 12068 and DIN 30672 for corrosion prevention with DENSOLEN® tapes. Please refer to the separate product information of the DENSOLEN®-HT primer.

DENSOLEN®-AS50

A real **co-extruded 3-ply plastic tape** made from stabilized polyethylene carrier material with butyl rubber adhesive. DENSOLEN®-AS50 has a thickness of ≥ 1.1 mm. DENSOLEN®-AS50 fulfills the international standards DIN 30672, EN 12068, ASTM and AWWA.

DENSOLEN®-R20HT

A real **co-extruded two-ply plastic tape** made from stabilized white polyethylene carrier film with a butyl rubber adhesive on one side. Outstanding connection between the adhesive and the carrier film is guaranteed by the co-extruded intermediate layer.

The adhesive layer grows completely together with the outside layer of **DENSOLEN®-AS50**. **DENSOLEN®-R20 HT** fulfills the international standards DIN 30672, EN 12068, ASTM and AWWA.

Typical product properties (Excerpt*)

Property	Unit	DENSOLEN®-AS50 – Typical value	DENSOLEN®-R20 HT – Typical value	Test method
Carrier film color	-	black	white	-
Butyl adhesive color inside	-	grey	black	-
Butyl adhesive color outside	-	black	-	-
Total thickness	mm	≥ 1.1	≥ 0.5	-
Carrier film thickness app.	mm	≥ 0.5	≥ 0.3	ISO 4591
Inside adhesive layer thickness app.	mm	≥ 0.5	≥ 0.2	ASTM D1000
Outside adhesive layer thickness app.	mm	≥ 0.1	-	-
Operating temperature	$^{\circ}\text{C}$ ($^{\circ}\text{F}$)	-40 to +50 (-40 to +122)		-
Elongation at break	%	≥ 550	≥ 550	DIN 30672
Tape strength	($+23^{\circ}\text{C}/+73^{\circ}\text{F}$) N/cm	≥ 95	≥ 65	EN 12068
Dielectric strength	kV / mm	≥ 40	≥ 35	DIN 53481

DENSOLEN®-AS50/-R20 HT with DENSOLEN®-HT Primer

Property	Unit	DENSOLEN®-AS50 Plus/R20 HT – Typical value		Test method
Specific electrical insulation resistance	Ω m ²	$\geq 10^{10}$		EN 12068
Peel resistance		($+23^{\circ}\text{C}/+73^{\circ}\text{F}$)	($+50^{\circ}\text{C}/+122^{\circ}\text{F}$)	
metal/primer/tape	N / cm	≥ 30	≥ 2.5	EN 12068
		≥ 33	≥ 2.5	ASTM D1000
Peel strength layer to layer		($+23^{\circ}\text{C}/+73^{\circ}\text{F}$)	($+50^{\circ}\text{C}/+122^{\circ}\text{F}$)	
AS50 / AS50		≥ 30	≥ 4	
AS50 / R20 HT	N / cm	≥ 25	≥ 3	EN 12068
R20HT / R20 HT		≥ 5	≥ 3	
Indentation resistance - residual layer thickness at stamp load 10N/mm ² (stamp-Ø 1.8 mm)	mm	(50°C/122°F)		EN 12068
Impact resistance	J	Impact resistance		
Cathodic disbondment resistance	mm	Cathodic disbondment resistance		EN 12068
Lap shear strength		Lap shear strength		
on steel		on steel		EN 12068
on factory coating	N / cm ²	On factory coating		
		≥ 15		EN 12068

* For further product information as well as details on ordering and packaging, please refer to the product data sheet at denso-group.com.

DENSOLEN®-E10/-090

Two-tape system for the field-joint coating of pipelines and pipeline components.

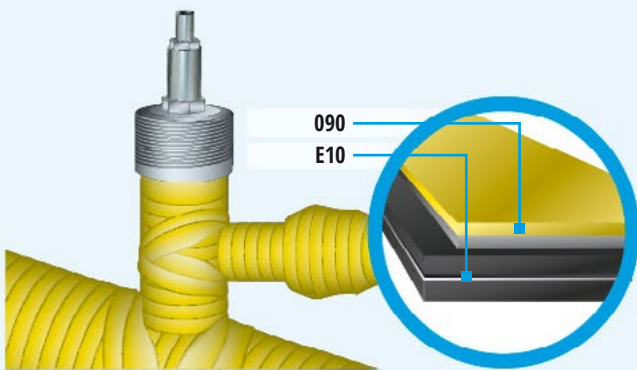

For temperatures from -50°C (-58°F) to +50°C (+122°F).



Real co-extruded three-ply tape.



Ideal for coatings in distribution networks.



Outstanding formability offered by inner and outer tape.



B30
EN 12068

Fulfills stress class B 30 in accordance with EN 12068.



Approval by Gaz de France (FR) for stress class R (RV02).

DENSOLEN®-E10/-090 is a durable corrosion prevention system for pipelines and pipeline components.

DENSOLEN®-E10/-090 is optimized for the requirements in urban supply networks. The **high flexibility and elasticity** of DENSOLEN®-E10 and DENSOLEN®-090 permit a **fast and safe application** of the field-joint coating system on the pipeline components, such as **T-fittings and house connection valves**.

The system is also ideally qualified for pipes with small nominal pipe diameter, even for tight construction site conditions.

DENSOLEN®-E10/-090 fulfills the requirements for stress class B 30 in accordance with EN 12068.

DENSOLEN®-E10/-090 has an approval by Gaz de France (France) for stress class R in accordance with the specifications RV02 (certificate No. 25).

Standard designation: 

• EN 12068 – B 30

DENSOLEN®-E10 as inside tape, fulfills essentially the corrosion prevention of the encasement system. DENSOLEN®-E10 consists of a double-sided butyl rubber coating, which is applied to the PE carrier film. This three-layer design establishes an essentially gas and water tight encasement in the overlapping area of the tape through self-amalgamation of the upper and lower butyl rubber coating. The large tape thickness of 1.0 mm **permits an optimal coverage of the surface, also for uneven surfaces**.

DENSOLEN®-090 is used as the outside tape in the encasement system.

DENSOLEN®-090 is a flexible two-ply tape with a polyethylene outside layer and an inside butyl rubber layer, which amalgamates with the outside layer of the inside tape. DENSOLEN®-090 acts as mechanical protection layer for the corrosion prevention tape located on the inside.

Both DENSOLEN® tapes can be processed efficiently with the **DENSOMAT® wrapping devices**.

Typical product properties (Excerpt*)

Property	Unit	DENSOLEN®-E10 – Typical value	DENSOLEN®-090 – Typical value	Test method
Carrier film color	-	-	yellow	-
Butyl adhesive color inside	-	black	grey	-
Butyl adhesive color outside	-	black	-	-
Tape thickness	mm	≥ 1.0	≥ 0.4	-
Carrier film thickness app.	mm	≥ 0.025	≥ 0.26	ISO 4591
Inside adhesive layer thickness app.	mm	≥ 0.5	≥ 0.14	ASTM D1000
Outside adhesive layer thickness app.	mm	≥ 0.48	-	-
Operating temperature	°C (°F)	-40 to +30 (-40 to +86)		-
Elongation at break	%	≥ 200	≥ 400	DIN 30672
Tape strength	N/cm	-	≥ 35	EN 12068

DENSOLEN®-E10/-090 with DENSOLEN®-HT Primer

Property	Unit	Typical value	Test method
Specific electrical insulation resistance	Ω m ²	≥ 10 ¹⁰	EN 12068
Peel resistance (+23°C/+73°F)	steel	≥ 15	EN 12068
	PE factory coating	≥ 10	EN 12068
Peel strength layer to layer	E10 / E10	≥ 30	-
	E10 / 090	≥ 20	EN 12068
Indentation resistance (residual layer thickness)	090 / 090	≥ 2	-
	(+23°C/+73°F) (1 MPa)	≥ 1	EN 12068 / RV02
Impact resistance	J	≥ 10	EN 12068
Cathodic disbondment resistance	mm	≤ 8	EN 12068
Lap shear strength	on steel N / cm ²	≥ 10	EN 12068

* For further product information as well as details on ordering and packaging, please refer to the product data sheet at denso-group.com.

DENSOLEN®-ET100/-R20 HT

High temperature two-tape system for the corrosion prevention coating of metal pipes and pipelines in accordance with DIN 30672, EN 12068, ASTM and AWWA. Especially qualified for high operating temperatures for district heating pipelines, oil lines and gas compressor stations.

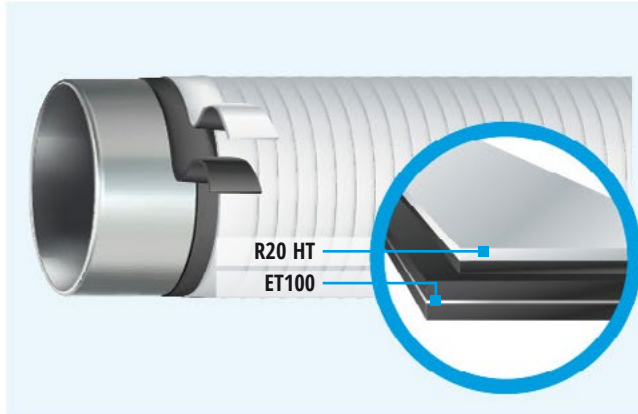

For temperatures from -50°C (-58°F) to +100°C (+212°F).



Excellent corrosion prevention for pipelines with increased temperature stress.



Especially thick and adaptable inner layer made from butyl rubber tape with a thickness of 1.0 mm.



Exceeds the requirements of stress class B 70 in accordance with EN 12068.



Compatible with factory coatings made of PE, PP, FBE, PU, CTE and bitumen.

DENSOLEN®-ET100/-R20HT is a cold applied high temperature two-tape system for the corrosion prevention of metal pipes and pipelines. DENSOLEN®-ET100/-R20 HT features outstanding properties and is especially suited for increased operating temperatures, e.g. for district heating pipelines, compressor stations and for oil lines.

DENSOLEN®-ET100/-R20 HT is a system approved by Enagás S.A. (Spain).

Standard designation:

- EN 12068 – B 70
- DIN 30672 – B 70



DENSOLEN®-ET100/-R20HT is essentially impermeable to water vapor and oxygen and is resistant against soil bacteria and electrolytes. DENSOLEN® ET100/-R20 HT is compatible with factory coatings made of PE, PP, FBE, PU, CTE and bitumen.

The system DENSOLEN®-ET100/-R20 HT consists of:

DENSOLEN®-HT Primer

A solvent containing primer in accordance with EN 12068 and DIN 30672 for the corrosion prevention with DENSOLEN® tapes. Please refer to the separate product information of the DENSOLEN®-HT Primer.

DENSOLEN®-ET100

A real **co-extruded 3-ply butyl rubber tape** with butyl rubber adhesive on both sides of a carrier film made of stabilized polyethylene film. The special formulation of the butyl rubber adhesive in the DENSOLEN®-ET100/-R20 HT gives the tape an **extraordinary temperature stability up to +100°C (+212°F)**. DENSOLEN®-ET100 has a thickness of ≥ 1.0 mm. DENSOLEN®-ET100/-R20 HT fulfills the international standards DIN 30672, EN 12068, ASTM and AWWA.

DENSOLEN®-R20HT, a real **co-extruded 2-ply plastic tape** made from stabilized polyethylene carrier film with a butyl rubber adhesive on one side. Outstanding connection between the adhesive and the carrier film is guaranteed by the co-extruded intermediate layer. The adhesive layer grows completely together with the outside layer of DENSOLEN®-ET100.

DENSOLEN®-R20 HT fulfills the international standards DIN 30672, EN 12068, ASTM and AWWA.

DEPROTEC®-DRM PP1000 Plus

As a mechanically protecting outside layer, we recommend the use of DEPROTEC®-DRM PP1000 Plus rockshield as an additional mechanically protection for operating temperatures above +70°C (+158°F).

Typical product properties (Excerpt*)

Property	Unit	DENSOLEN®-ET100 – Typical value	DENSOLEN®-R20HT – Typical value	Test method
Carrier film color	-	colorless	white	-
Butyl adhesive color inside	-	black	black	-
Butyl adhesive color outside	-	black	-	-
Total thickness	mm	≥ 1.0	≥ 0.5	-
Carrier film thickness app.	mm	≥ 0.025	≥ 0.3	ISO 4591
Inside adhesive layer thickness app.	mm	≥ 0.5	≥ 0.2	ASTM D1000
Outside adhesive layer thickness app.	mm	≥ 0.5	-	-
Operating temperature	°C (°F)	-40 to +70 (-40 to +158)	-	-
Elongation at break	%	≥ 200	≥ 550	DIN 30672
Tape strength	N/cm (+23°C/+73°F)	-	≥ 65	EN 12068
Dielectric strength	kV / mm	≥ 35	≥ 35	DIN 53481

DENSOLEN®-ET100/-R20 HT with DENSOLEN®-HT Primer

Property	Unit	Typical value					Standard
		(+23°C/+73°F)	(+50°C/+122°F)	(+70°C/+158°F)	(+85°C/+185°F)	(+100°C/+212°F)	
Specific electrical insulation resistance	$\Omega \text{ m}^2$	-	-	$\geq 10^{10}$	-	-	DIN EN 12068
Peel strength on steel	N / cm	30	5	2.5 **	1.4 **	0.8 **	DIN EN 12068
Peel strength layer to layer – ET100/ET100, ET100/R20 HT	N / cm	22	-	-	-	-	DIN EN 12068
Indentation resistance, residual layer thickness of the tape system without rockshield	Extra load 10 N / mm ² Stamp-Ø 1.8 mm ²	-	2.1	1.6	0.9	-	DIN EN 12068
	Extra load 1 N / mm ² Stamp-Ø 5.65 mm ²	-	-	2.1	1.8	0.9	
Impact resistance	J	-	-	16	-	-	DIN EN 12068
Cathodic disbondment (radius)	mm	8	28	-	-	-	DIN EN 12068
		8	-	-	-	-	ASTM G 8
Lap shear strength	N / cm ²	15	6	5 **	4.8 **	4.5 **	DIN EN 12068
System design	Primer	DENSOLEN®-HT Primer					-
	Inner tape	DENSOLEN®-ET10 (2 layers)					
	Outer tape	DENSOLEN®-R20 HT (2 layers)					
	Mechanical protection	DENSOLEN®-DRM PP1000 Plus					
Thickness of the encasement (without DENSOLEN®-DRM PP1000 Plus)	mm	3.0					-

** Values after 7 days conditioning at the test temperature.

* For further product information as well as details on ordering and packaging, please refer to the product data sheet at denso-group.com.

DENSOLEN®-N15/-PE3

Two-tape system for corrosion prevention coating of metal pipes, pipelines, containers and fittings according to EN 12068 and DIN 30672.

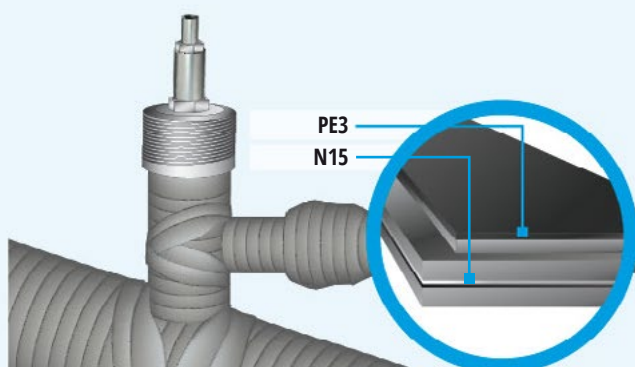

For temperatures from -50°C (-58°F) to +70°C (+158°F).



Especially thick and adaptable inner layer made from butyl rubber tape with a thickness of 1.5mm.



Fulfills EN 12068-B30 and DIN 30672-B30.



Outstanding formability offered by inner and outer tape.



Ideal for coatings in distribution networks.



Compatible with factory coatings made of PE, PP, FBE, PU, CTE and bitumen.

DENSOLEN®-N15/-PE3 is a cold-applied two-tape system for the corrosion protection of metal pipes and fittings. DENSOLEN®-N15/-PE3 is optimized to meet the requirements of municipal supply networks. The **great flexibility and elasticity** shown by DENSOLEN®-N15 and DENSOLEN®-PE3 enables **rapid and reliable application** of coating system on pipeline parts such as T-fittings and house connection valves. The system is also ideally suited to pipes with small nominal pipe sizes, even in tight construction site conditions.

DENSOLEN®-N15/-PE3 is effectively impermeable to water vapor and oxygen, and is resistant to soil bacteria and electrolytes.

DENSOLEN®-N15/-PE3 is compatible with factory coatings made from PE, PP, FBE, PU, CTE and bitumen.

As an inner tape, **DENSOLEN®-N15** assumes the major corrosion prevention properties of the system. DENSOLEN®-N15 consists of a double-sided butyl rubber adhesive coating, which is applied to the **co-extruded PE film** located on the inside. In the overlapping area of the tape, this 3-ply design establishes a wrapping that is effectively impermeable to gas and water by means of the self-amalgamation of the upper and lower butyl rubber layer. The adaptable butyl rubber adhesive layer makes it possible for DENSOLEN®-N15 to **adapt optimally to uneven substrates**.

DENSOLEN®-PE3 is a genuine **co-extruded 2-ply polymeric tape** made from a stabilized black polyethylene carrier film with a butyl rubber adhesive on one side. The thickness is ≥ 0.4 mm. The co-extruded intermediate layer ensures an outstanding bond between the adhesive and the carrier film. The adhesive layer fuses completely with the outer layer of DENSOLEN®-N15.

DENSOLEN®-PE3 is used as the outer tape in the wrapping system. A simple layer (wrap with app. 1 cm of overlap) of DENSOLEN®-PE3 tape is sufficient to **satisfy** the medium **stress class B of EN 12068 and DIN 30672**.

Both **DENSOLEN®** tapes can be effectively processed with the **DENSOMAT® wrapping devices**.

Typical product properties (Excerpt*)

Property	Unit	DENSOLEN®-N15 – Typical value	DENSOLEN®-PE3 – Typical value	Test method
Carrier film color	-	black	black	-
Butyl adhesive color (inner)	-	grey	grey	-
Butyl adhesive color (outer)	-	grey	-	-
Total thickness	mm	≥ 1.5	≥ 0.4	
Carrier film thickness (app.)	mm	≥ 0.07	≥ 0.22	ISO 4591
Inner adhesive layer thickness (app.)	mm	≥ 0.75	≥ 0.18	ASTM D1000
Outer adhesive layer thickness (app.)	mm	≥ 0.68	-	
Operating temperature	°C (°F)	-40 to +50 (-40 to +122)	-	-
Elongation at break	%	-	≥ 250	DIN 30672
Tensile strength (+23°C/+73°F)	N/cm	-	≥ 40	EN 12068
Dielectric strength	kV / mm	≥ 40	≥ 40	DIN 53481

DENSOLEN®-N15/-PE3 with DENSOLEN®-HT Primer

Property	Unit	Typical value	Test method
Specific electrical insulation resistance	$\Omega \cdot m^2$	$\geq 10^{11}$	EN 12068
Peel resistance (+23°C/+73°F)	Steel	≥ 15	EN 12068
	PE factory coating	≥ 15	EN 12068
Peel resistance layer/layer	N15 / N15	≥ 30	
	N15 / PE3	≥ 15	EN 12068
Indentation resistance (residual layer thickness)	PE3 / PE3	≥ 2	
	(+23°C/+73°F) (1 MPa)	≥ 1.2	EN 12068 / RV02
Impact resistance	J	≥ 8	EN 12068
cathodic disbondment resistance	mm	<13	EN 12068
Lap shear strength on steel	N / cm ²	≥ 10	EN 12068

* For further product information as well as details on ordering and packaging, please refer to the product data sheet at denso-group.com.

DENSOLEN®-N15/-PE5

Two-tape system for the corrosion prevention coating of metal pipes, pipelines and containers in accordance with DIN 30672, EN 12068, ASTM and AWWA. For extreme corrosion conditions and mechanical stresses on uneven substrates.

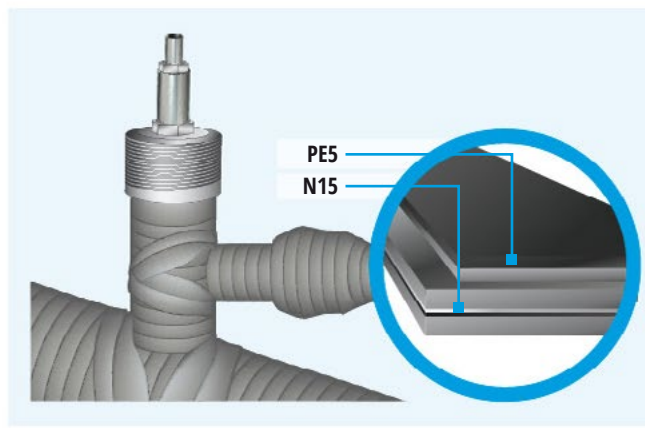

-  For temperatures from -50°C (-58°F) to +70°C (+158°F).
-  Especially thick and adaptable inner layer made from butyl rubber tape with a thickness of 1.5mm.
-  Ideal for uneven surfaces.
-  Excellent corrosion protection and exceptionally easy to apply.
-  Fulfills EN 12068-C30 and DIN 30672-C30.
-  Compatible with factory coatings made of PE, PP, FBE, PU, CTE and bitumen.

DENSOLEN®-N15/-PE5 is a cold applied two-tape system for corrosion prevention of metal pipes and moldings with special qualification for the application of uneven substrates and complicated geometries.

A flexible butyl rubber adhesive layer with a thickness of 1.5 mm makes it possible for DENSOLEN®-N15 to adapt **optimally to uneven substrates** even with **complicated geometries**.

DENSOLEN®-N15/-PE5 is essentially impermeable for water vapor and oxygen and it is resistant against soil bacteria and electrolytes.

DENSOLEN®-N15/-PE5 is compatible with factory coatings made of PE, PP, FBE, PU, CTE and Bitumen.

The system DENSOLEN®-N15/-PE5 consists of:

DENSOLEN®-HT Primer is a solvent containing primer in accordance with EN 12068 and DIN 30672 for corrosion prevention with DENSOLEN® tapes. Please refer to the separate product information of the DENSOLEN®-HT Primer.

DENSOLEN®-N15 is a real **co-extruded 3-ply butyl rubber tape** with butyl rubber adhesive on both sides and a carrier film made from stabilized polyethylene film. DENSOLEN®-N15 has a thickness of ≥1.5mm. DENSOLEN®-N15 fulfills the international standards DIN 30672, EN 12068, ASTM and AWWA.

DENSOLEN®-PE5 is a real **co-extruded two-ply plastic tape** made from stabilized black polyethylene carrier film with a butyl rubber adhesive on one side. The thickness is ≥ 0.5 mm.

Outstanding connection between the adhesive and the carrier film due to the co-extruded intermediate layer. The adhesive layer grows completely together with the outside layer of DENSOLEN®-N15. DENSOLEN®-PE5 fulfills the international standards DIN 30672, EN 12068, ASTM and AWWA.

Typical product properties (Excerpt*)

Property	Unit	DENSOLEN®-N15 – Typical value	DENSOLEN®-PE5 – Typical value	Test method
Carrier film color	-	black	black	-
Butyl adhesive color inside	-	grey	grey	-
Butyl adhesive color outside	-	grey	-	-
Total thickness	mm	≥ 1.5	≥ 0.5	
Carrier film thickness app.	mm	≥ 0.07	≥ 0.3	ISO 4591 ASTM D1000
Inside adhesive layer thickness app.	mm	≥ 0.75	≥ 0.2	
Outside adhesive layer thickness app.	mm	≥ 0.68	-	
Operating temperature	°C (°F)		-40 to +50 (-40 to +122)	-
Elongation at break	%	-	≥ 450	DIN 30672
Tape strength	(+23°C/+73°F) N/cm	-	≥ 60	EN 12068
Dielectric strength	kV / mm	≥ 40	≥ 40	DIN 53481

DENSOLEN®-N15/-PE5 (2+2 Lagen) with DENSOLEN®-HT Primer

Property	Unit	DENSOLEN®-N15/-PE5 – Typical value		Test method
Specific electrical insulation resistance	Ω m ²	≥ 10 ¹²		EN 12068
Peel strength		(+23°C/+73°F)	(+30°C/+86°F)	
metal/primer/tape	N / cm	≥ 15	≥ 1.5	EN 12068
		≥ 18	≥ 1.8	ASTM D1000
Peel strength layer to layer		(+23°C/+73°F)	(+30°C/+86°F)	
N15 / N15		≥ 30	≥ 2	
N15 / PE5	N / cm	≥ 15	≥ 2	EN 12068
PE5 / PE5		≥ 2	≥ 2	
Indentation resistance - residual layer thickness for stamp load (stamp-Ø 1.8 mm)	mm / N/mm ²	+30°C (+86°F)		EN 12068
		≥ 0.6		
Impact resistance	J	≥ 15		EN 12068
Cathodic disbondment resistance	mm	≤ 10		ASTM G8
Lap shear strength	on steel N / mm ²	≥ 10		

* For further product information as well as details on ordering and packaging, please refer to the product data sheet at denso-group.com.

DENSOLEN®-N60/-S20

Two-tape system for the corrosion prevention of metal pipes and pipelines in accordance with DIN 30672, EN 12068, ASTM and AWWA. Based on the good adaptability to unevennesses, especially qualified for the demanding use on pipes with large diameters.

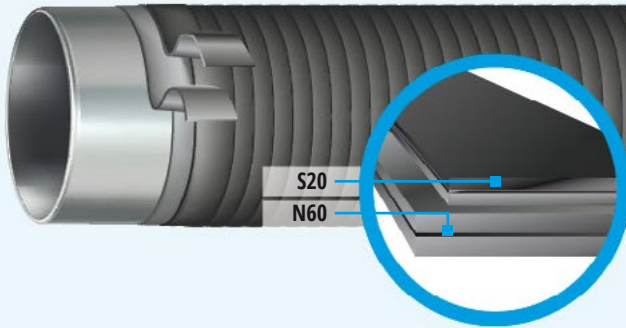

For temperatures from -50°C (-58°F) to +70°C (+158°F).



The system consists of two real co-extruded three-ply tapes.



Adapts perfectly to large beads and edges.



Fulfills EN 12068-C50 and DIN 30672-C50.



Fulfills the requirements of ISO 21809-3; Type 12A-1.



Compatible with factory coatings made of PE, PP, FBE, PU, CTE and bitumen.

DENSOLEN®-N60/-S20 is a cold applied two-tape system for the corrosion prevention of metal pipes and pipelines with small to very large diameters.

By using 3-ply tape as inside and outside tape, each in 2 layers, **all 4 tape layers** of the system **grow completely together** due to the innovative formula.

DENSOLEN®-N60/-S20 is basically impermeable for water vapor and oxygen and it is resistant against soil bacteria and electrolytes.

DENSOLEN®-N60/-S20 is compatible with factory coatings made of PE, PP, FBE, PU, CTE and Bitumen.

The system **DENSOLEN®-N60/-S20** consists of:

DENSOLEN®-HT Primer

A solvent containing primer in accordance with EN 12068 and DIN 30672 for corrosion prevention with DENSOLEN® tapes. Please refer to the separate product information of the DENSOLEN®-HT Primer.

DENSOLEN®-N60

A real **co-extruded three-layer plastic tape** made from stabilized polyethylene carrier material with butyl rubber adhesive. DENSOLEN®-N60 has a thickness of ≥ 1.2 mm.

The butyl rubber adhesive layer is especially thick with ≥ 1.0 mm, providing the best corrosion protection. DENSOLEN®-N60 fulfills the international standards DIN 30672, EN 12068, ASTM and AWWA.

DENSOLEN®-S20

A real **co-extruded 3-ply plastic tape** made from stabilized polyethylene carrier materials with butyl rubber adhesive. DENSOLEN®-S20 has a thickness of ≥ 0.5 mm. The adhesive layer grows completely together with the outside layer of DENSOLEN®-N60 and with itself in the overlapping area.

DENSOLEN®-S20 fulfills the international standards DIN 30672, EN 12068, ASTM and AWWA.

Typical product properties (Excerpt*)

Property	Unit	DENSOLEN®-N60 – Typical value	DENSOLEN®-S20 – Typical value	Test method
Carrier film color	-	black	black	-
Butyl adhesive color inside	-	grey	grey	-
Butyl adhesive color outside	-	grey	black	-
Total thickness	mm	≥ 1.2	≥ 0.5	ISO 4591 ASTM D1000
Carrier film thickness app.	mm	≥ 0.14	≥ 0.28	
Inside adhesive layer thickness app.	mm	≥ 1.0	≥ 0.16	
Outside adhesive layer thickness app.	mm	≥ 0.06	≥ 0.06	
Operating temperature	°C (°F)	-40 to +50 (-40 bis +122)		-
Elongation at break	%	≥ 450	≥ 600	DIN 30672
Tape strength (+23°C/+73°F)	N/cm	≥ 40	≥ 100	EN 12068
Dielectric strength	kV / mm	≥ 40	≥ 40	DIN 53481

DENSOLEN®-N60/-S20 with DENSOLEN®-HT Primer

Property	Unit	DENSOLEN®-N60/-S20 – Typical value		Test method
Specific electrical insulation resistance	$\Omega \text{ m}^2$	$\geq 10^{11}$		EN 12068
Peel strength		(+23°C/+73°F)	(+50°C/+122°F)	
Metal/primer/tape	N / cm	≥ 30	≥ 2.5	EN 12068
		≥ 33	≥ 2.5	ASTM D1000
Peel strength layer to layer		(+23°C/+73°F)	(+50°C/+122°F)	
N60 / N60		≥ 30	≥ 3.5	
N60 / S20	N / cm	≥ 25	≥ 3	EN 12068
S20 / S20		≥ 25	≥ 3	
Indentation resistance -residual layer thickness (1 N/mm ² stamp load, stamp-Ø 5.65 mm)	mm	(50°C/+122°F)		EN 12068
		≥ 0.7		
Impact resistance	J	> 15		EN 12068
Cathodic disbondment resistance	mm	≤ 6		ASTM G8
Lap shear strength		(23°C/+73°F)		
on steel		≥ 0.15		
on PE factory coating	N / mm ²	≥ 0.15		EN 12068

* For further product information as well as details on ordering and packaging, please refer to the product data sheet at denso-group.com.

DENSOLEN®-S10/-090

Two-tape system for the field-joint coating of pipelines and pipeline components.

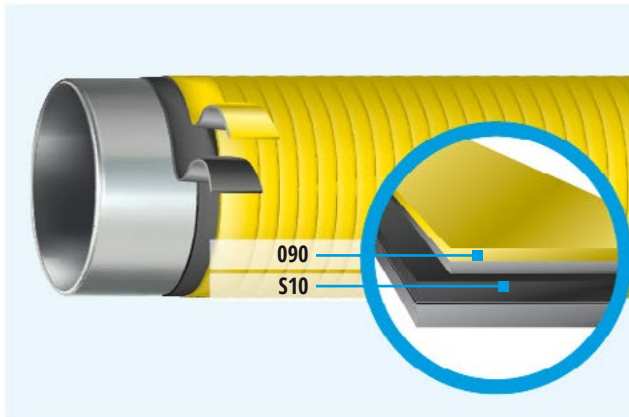

For temperatures from -50°C (-58°F) to +70°C (+158°F).



Approval by GRTgaz (FR) for stress classes R and HR (RV02).



Compatible with factory coatings made of PE, PP, PUR, FBE and bitumen.



Two-tape system for flanges, T-pieces and other moulded parts.

DENSOLEN®-S10/-090 is a tape system for the permanent corrosion prevention of pipelines and pipeline components.

The **high flexibility** and **elasticity** of DENSOLEN®-S10 and DENSOLEN®-090 permit a **fast and safe application** of the field-joint coating systems on the pipeline components, such as **T-fittings and house connection valves**.

Depending on the number of tape layers of the outside tape, the stress classes R or HR of GRTgaz are achieved. Based on the **modular design**, this DENSOLEN® tape system can be used to establish the **technically and economically optimal system** in accordance with the requirements of the construction project. DENSOLEN®-S10/-090 has an approval by GRTgaz (France) for stress class R and HR in accordance with the specifications RV02 (certificate No. 70).

DENSOLEN®-S10 as an inside tape, fulfills essentially the corrosion prevention of the encasement system. DENSOLEN®-S10 features an especially adaptable carrier film and a symmetrical butyl rubber coating on both sides. The butyl rubber layers grow completely together in the overlapping area and create a **durable and hose-type coating**.

DENSOLEN®-090 is used as the outside tape in the encasement system and provides the mechanical protection for the inside tape. DENSOLEN®-090 is a flexible two-layer tape with a polyethylene outside layer and an inside butyl rubber coating, which amalgamates with the outside layer of the inside tape.

Both DENSOLEN® tapes can be processed efficiently with the **DENSOMAT® wrapping devices**.

Typical product properties (Excerpt*)

Property	Unit	DENSOLEN®-S10 – Typical value	DENSOLEN®-090 – Typical value	Test method
Carrier film color	-	black	yellow	-
Butyl adhesive color inside	-	grey	grey	-
Butyl adhesive color outside	-	black	-	-
Tape thickness	mm	≥ 0.8	≥ 0.4	-
Carrier film thickness app.	mm	≥ 0.14	≥ 0.26	ISO 4591
Inside adhesive layer thickness app.	mm	≥ 0.38	≥ 0.14	ASTM D1000
Outside adhesive layer thickness app.	mm	≥ 0.28	-	-
Operating temperature	°C (°F)	-40 to +50 (-40 bis +122)		-
Elongation at brea	%	≥ 500	≥ 400	DIN 30672
Tape strength	N/cm	≥ 40	≥ 35	EN 12068

Property	Unit	Typical value		Test method	
		Class R	Class HR		
Specific electrical insulation resistance	Ω.m²	≥ 10 ¹⁰	≥ 10 ¹⁰	EN 12068	
Peel strength on steel	N / cm	(+23°C/+73°F)	≥ 20	≥ 20	EN 12068
		(+50°C/+122°F)	≥ 3	≥ 3	
Peel strength layer to layer	N / cm	S10 / S10	≥ 25	≥ 25	EN 12068
		S10 / 090	≥ 10	≥ 10	
		090 / 090	≥ 2	≥ 2	
Indentation resistance	(+50°C/+122°F) mm	≥ 0.6 (1 MPa)	≥ 0.6 (10 MPa)	EN 12068	
Impact resistance	J	≥ 10	≥ 15	GdF RV02	
Cathodic disbondment resistance	mm	≤ 8	≤ 8	EN 12068	
Lap shear strength on Steel	(+23°C/+73°F) N / cm²	≥ 15	≥ 15	EN 12068	
System design	Primer	DENSOLEN®-HT Primer		-	
	Inner tape	DENSOLEN®-S10			
	Outer tape	DENSOLEN®-090			
Total thickness	mm	1 layer	2 layer	-	
Stress class	-	≥ 2.0	≥ 2.4	RV 02	
		R	HR		

* For further product information as well as details on ordering and packaging, please refer to the product data sheet at denso-group.com.

DENSOLEN® System 1

DENSOLEN®-E12/-090/-R20 HT

Robust field coating system for the corrosion prevention of pipelines and pipeline components.

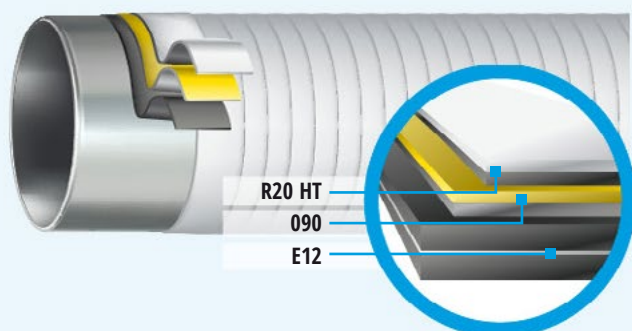

For temperatures from -50°C (-58°F) to +70°C (+158°F).



Highly resistant thanks to three-tape design.



Fulfills stress class C 30 in accordance with EN 12068 and ÖNORM B 5250.



Easy application even for manual wrapping.

DENSOLEN® System 1 is a robust field coating system for the permanent corrosion prevention of pipelines and pipeline components. DENSOLEN® System 1 is a highly stressable system based on its design of **three DENSOLEN® tapes**.

The **requirements** for the stress class C 30 in accordance with EN 12068 and ÖNORM B 5250 **are exceeded**.

Standard designation:

- EN 12068 - C 30
- ÖNORM B 5250 - C 30

DENSOLEN® System 1 consists of three DENSOLEN® tapes that have been proven for a long time:

DENSOLEN®-E12 is a soft butyl rubber tape, which – as the inner tape – assumes the major corrosion prevention properties of the system. The thick butyl rubber layer of the system permits an **outstanding molding of unevenly formed surfaces**

and an easy manual processing, e.g. on pipelines with small nominal pipe sizes, pipe bends and house connection valves. Due to its self-amalgamation effect in the overlapping area, DENSOLEN®-E12 creates an essentially gas and water tight as well as electrically high insulating encasement.

DENSOLEN®-090 is used as the middle layer in the coating system. It is a flexible two-ply tape with a polyethylene outside layer and a butyl rubber coating positioned on the inside. The applied winding tension presses the inner tape solidly to the component surface and supports the self-amalgamation of the inner tape.

DENSOLEN®-R20 HT is a robust two-ply tape. The solid polyethylene outside layer protects the encasement against mechanical stresses.

All three DENSOLEN® tapes can be processed efficiently with the **DENSOMAT® wrapping devices**.

Typical product properties (Excerpt*)

Property	Unit	DENSOLEN®-E12 – Typical value	DENSOLEN®-090 – Typical value	DENSOLEN®-R20 HT – Typical value	Test method
Carrier film color	-	-	yellow	white, black, or blue	-
Butyl adhesive color inside	-	black	black	black	-
Butyl adhesive color outside	-	black	-	-	-
Tape thickness	mm	≥ 1.2	≥ 0.4	≥ 0.5	ISO 4591 ASTM D1000
Carrier film thickness app.	mm	≥ 0.025	≥ 0.22	≥ 0.3	
Inside adhesive layer thickness app.	mm	≥ 0.73	≥ 0.18	≥ 0.2	
Outside adhesive layer thickness app.	mm	≥ 0.45	-	-	
Operating temperature	°C (°F)	-	-40 to +30 (-40 to +86)	-	
Elongation at break	%	-	≥ 400	≥ 500	DIN 30672
Tape strength (+23°C/+73°F)	N/cm	-	≥ 35	≥ 65	EN 12068
Dielectric strength	kV / mm	-	-	≥ 50	ASTM D149

Property	Unit	DENSOLEN® System 1 – Typical value	Test method
Specific electrical insulation resistance	Ω m²	≥ 10 ¹⁰	EN 12068
Peel strength metal/primer/tape	N / cm	≥ 15	EN 12068 ASTM D1000
Peel strength layer to layer	N / cm	E12 / E12	≥ 30
		E12 / 090	≥ 20
		090 / 090	≥ 2
		R20 HT / R20 HT	≥ 3
Indentation resistance (residual layer thickness) (stamp load 10MPa)	mm	> 0.8	EN 12068
Impact resistance	J	> 15	EN 12068
Cathodic disbondment (radius)	mm	< 8	EN 12068
Lap shear strength	on steel N / cm²	> 15	EN 12068
System design	Primer	DENSOLEN®-HT Primer	-
	Inner tape	DENSOLEN®-E12, 2 Lagen	-
	Tensioning tape	DENSOLEN®-090, 2 Lagen	-
	Outer tape	DENSOLEN®-R20 HT, 2 Lagen	-
Total thickness	mm	≥ 4.2	-

* For further product information as well as details on ordering and packaging, please refer to the product data sheet at denso-group.com.

DENSOLEN® System 2

DENSOLEN®-N12/-090/-R20 HT

Robust field coating system for the corrosion prevention of pipelines and pipeline components.

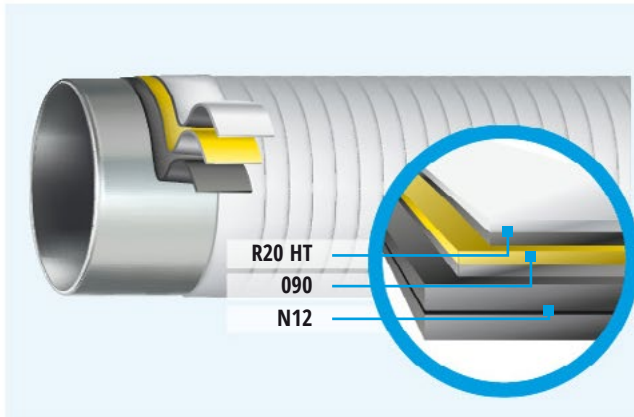

For temperatures from -50°C (-58°F) to +70°C (+158°F).



Highly resistant thanks to three-tape design.



ÖVGW approval for stress class C 50 in accordance with EN 12068 and ÖNORM B 5250.



Proven over many years in countless pipeline projects.

DENSOLEN® System 2 is a robust field coating system for the permanent corrosion prevention of pipelines and pipeline components. DENSOLEN® System 2 is a highly stressable system based on its design of **three DENSOLEN® tapes**, which has proven itself outstandingly in many construction measures on transportation and distribution pipelines.

DENSOLEN® System 2 features an ÖVGW approval for the stress class C 50 in accordance with EN 12068 and ÖNORM B 5250. The requirements for this standard are exceeded.

Standard designation:

- EN 12068 - C 50
- ÖNORM B 5250 - C 50



DENSOLEN® System 2 consists of three DENSOLEN® tapes that have been proven for a long time:

DENSOLEN®-N12 as the inner tape, assumes the major corrosion prevention properties of the system. The thick butyl rubber layer of the tape **equalizes unevenly formed surfaces** and permits an easy processing on pipelines with small as well as large nominal pipe sizes. Due to its self-amalgamation effect in the overlapping area, DENSOLEN®-N12 creates an essentially gas and water tight as well as electrically high insulating encasement.

DENSOLEN®-090 is used as the middle layer in the encasement system. It is a flexible two-ply tape with a polyethylene outside layer and a butyl rubber coating positioned on the inside. The applied winding tension presses the inside tape solidly to the component surface and thus supports the self-amalgamation of the inside tape.

DENSOLEN®-R20 HT is a robust two-ply tape. The solid polyethylene outside layer protects the coating against mechanical stresses.

All three DENSOLEN® tapes can be processed efficiently with the **DENSOMAT® wrapping devices**.

Typical product properties (Excerpt*)

Property	Unit	DENSOLEN®-N12 – Typical value	DENSOLEN®-090 – Typical value	DENSOLEN®-R20 HT – Typical value	Test method
Carrier film color	-	-	yellow	white, black or blue	-
Butyl adhesive color inside	-	grey	grey	black	-
Butyl adhesive color outside	-	grey	-	-	-
Tape thickness	mm	≥ 1.2	≥ 0.4	≥ 0.5	-
Carrier film thickness app.	mm	≥ 0.07	≥ 0.26	≥ 0.3	ISO 4591
Inside adhesive layer thickness app.	mm	≥ 0.7	≥ 0.14	≥ 0.2	ASTM D1000
Outside adhesive layer thickness app.	mm	≥ 0.43	-	-	-
Operating temperature	°C (°F)	-	-40 to +50 (-40 bis +122)	-	-
Elongation at break	%	≥ 500	≥ 400	≥ 500	DIN 30672
Tape strength (+23°C/+73°F)	N/cm	≥ 30	≥ 35	≥ 65	EN 12068
Dielectric strength	kV / mm	-	-	≥ 50	ASTM D149

Property	Unit	DENSOLEN® System 2 – Typical value		Test method
Specific electrical insulation resistance	Ω m ²	≥ 10 ¹⁰		EN 12068
Peel strength to steel	N / cm	(+23°C/+73°F)	≥ 15	EN 12068
		(+50°C/+122°F)	≥ 5	
Peel strength layer to layer	N / cm	N12 / N12	≥ 30	EN 12068
		N12 / 090	≥ 25	
		090 / 090	≥ 2	
Indentation resistance (residual layer thickness)	mm	≥ 0.6		EN 12068
Impact resistance	J	> 20		EN 12068
Cathodic disbondment (radius)	mm	< 9		EN 12068
Lap shear strength on steel	N / cm ²	> 15		EN 12068
System design	Primer	DENSOLEN®-HT Primer		-
	Inner tape	DENSOLEN®-N12, 2 Lagen		
	Tensioning tape	DENSOLEN®-090, 2 Lagen		
	Outer tape	DENSOLEN®-R20 HT, 2 Lagen		
Total thickness	mm	≥ 4.2		-

* For further product information as well as details on ordering and packaging, please refer to the product data sheet at denso-group.com.

DENSOLEN® System 3

DENSOLEN®-032-65 AS/-090/-R20 HT

Robust field coating system for the corrosion prevention of pipelines and pipeline components.

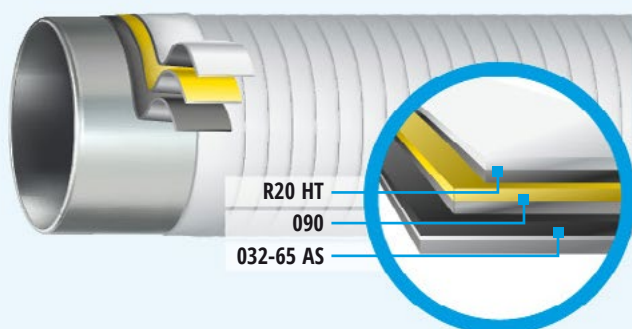

For temperatures from -50°C (-58°F) to +70°C (+158°F).



Highly resistant thanks to the three-tape design.



ÖVGW approval for stress class C 50 in accordance with EN 12068 and ÖNORM B 5250.

DENSOLEN® System 3 is a field coating system for the permanent corrosion prevention of pipelines and pipeline components. DENSOLEN® System 3 is a highly stressable system based on its design of **three DENSOLEN® tapes**. An essentially gas and watertight as well as electrically highly insulating encasement will be created due to the **self-amalgamation effect** of the inside tape **DENSOLEN®-032-65 AS**.

DENSOLEN® System 3 features an ÖVGW approval for the stress class C 50 in accordance with EN 12068 and ÖNORM B 5250. The requirements for this standard are significantly exceeded.

Standard designation:

- EN 12068 - C 50
- ÖNORM B 5250 - C 50



DENSOLEN® System 3 consists of three DENSOLEN® tapes:

DENSOLEN®-032-65 AS as the inner tape, assumes the major corrosion prevention properties of the system. DENSOLEN®-032-65 AS is a **co-extruded 3-ply tape** with an **asymmetrical layer design**. Even for a relative thin tape thickness of 0.65 mm with this design, a thick butyl rubber layer is placed on the pipe surface and it provides an **outstanding adhesive connection even if the pipe surface is uneven**. A self-amalgamation effect will be achieved in the overlapping area due to the thin butyl rubber layer at the upper side of the tape.

The low tape thickness results also in a good processability at pipe bends and fittings.

DENSOLEN®-090 is used as the middle layer in the encasement system. It is a flexible two-ply tape with a polyethylene outside layer and a butyl rubber coating positioned on the inside. The applied winding tension presses the inside tape solidly to the component surface and therefore supports the self-amalgamation of the inside tape.

DENSOLEN®-R20 HT is a robust two-ply tape. The solid polyethylene outside layer protects the encasement against mechanical stresses.

Typical product properties (Excerpt*)

Property	Unit	DENSOLEN®-032-65 AS – Typical value	DENSOLEN®-090 – Typical value	DENSOLEN®-R20 HT – Typical value	Test method
Carrier film color	-	black	yellow	white, black or blue	-
Butyl adhesive color inside	-	grey	grey	black	-
Butyl adhesive color outside	-	black	-	-	-
Tape thickness	mm	≥ 0.65	≥ 0.4	≥ 0.5	-
Carrier film thickness app.	mm	≥ 0.18	≥ 0.26	≥ 0.3	ISO 4591
Inside adhesive layer thickness app.	mm	≥ 0.39	≥ 0.14	≥ 0.2	ASTM D1000
Outside adhesive layer thickness app.	mm	≥ 0.08	-	-	-
Operating temperature	°C (°F)	-	-40 to +50 (-40 to +122)	-	-
Elongation at break	%	≥ 550	≥ 400	≥ 500	DIN 30672
Tape strength	N/cm (+23°C/+73°F)	≥ 50	≥ 35	≥ 65	EN 12068
Dielectric strength	kV / mm	-	-	≥ 50	ASTM D149

Property	Unit	DENSOLEN® System 3 – Typical value	Test method
Specific electrical insulation resistance	Ω m²	≥ 10 ¹⁰	EN 12068
Peel strength	on steel	(+23°C/+73°F) ≥ 15	EN 12068
	on PE	(+50°C/+122°F) ≥ 2	EN 12068
Peel strength layer to layer	032-65 AS / 032-65 AS	(+23°C/+73°F) ≥ 10	EN 12068
	032-65 AS / 090	≥ 22	-
	090 / 090	≥ 22	EN 12068
Peel strength layer to layer	090 / 090	≥ 2	-
	R20 HT / R20 HT	≥ 3	-
Indentation resistance (residual layer thickness)	mm (+23°C/+73°F) (10 MPa)	≥ 0.8	EN 12068
Impact resistance	J	≥ 20	EN 12068
Cathodic disbondment resistance	mm	< 2	EN 12068
Lap shear strength on steel	N / cm²	≥ 8	EN 12068
System design	Primer	DENSOLEN®-HT Primer	-
	Inside tape	DENSOLEN®-032-65 AS, 2 Lagen	-
	Tensioning tape	DENSOLEN®-090, 2 Lagen	-
	Outside tape	DENSOLEN®-R20 HT, 2 Lagen	-
Total thickness	mm	≥ 3.1	-

* For further product information as well as details on ordering and packaging, please refer to the product data sheet at denso-group.com.

DENSOLEN® System 4

DENSOLEN®-032-65 AS/-090

Robust two-tape field coating system for the corrosion prevention of pipelines and pipeline components.

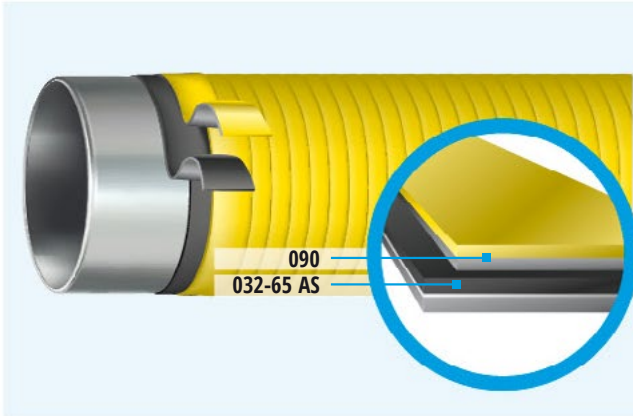

For temperatures from -50°C (-58°F) to +70°C (+158°F).



Optimal for the coating of moulded parts.



ÖVGW approval for stress class C 50 in accordance with EN 12068 and ÖNORM B 5250.

DENSOLEN® System 4 is a two-tape field coating system for the permanent corrosion prevention of pipelines and pipeline components. DENSOLEN® System 4 due to its design of two thin and well formable DENSOLEN® tapes is **optimally qualified for the encasement** of pipeline components such as **T-fittings, flanges, sleeves or pipe elbows with small nominal pipe size**. Based on the **multi-layer design, a coating system** is created **for high mechanical and corrosive stresses**.

DENSOLEN® System 4 features an ÖVGW approval for stress class C 50 in accordance with EN 12068 and ÖNORM B 5250.

Standard designation:

- EN 12068 - C 50
- ÖNORM B 5250 - C 50



DENSOLEN® System 4 consists of the following DENSOLEN® tapes:

DENSOLEN®-032-65 AS as the inside tape, assumes the major corrosion prevention properties of the system.

DENSOLEN®-032-65 AS is a **co-extruded 3-ply tape** with an **asymmetrical layer design**. This design with a relative thin tape thickness of 0.65 mm provides nevertheless a thick butyl rubber coating on the pipe surface and therefore it provides an **outstanding adhesive connection even if the pipe surface is uneven**.

Due to the butyl rubber layer at the upper side of the tape, a self-amalgamation effect will be achieved in the overlapping area and an essentially gas and watertight as well as electrically high insulating encasement will be created.

In the DENSOLEN® System 4, DENSOLEN®-032-65 AS is used as corrosion prevention tape (winding with $\geq 50\%$ overlapping) as well as a tensioning tape (winding with $\geq 66\%$ overlapping).

DENSOLEN®-090 is used as the outside tape in the encasement system.

DENSOLEN®-090 is a flexible two-ply tape with a polyethylene outside layer and an inside butyl rubber adhesive, which welds together with the outside layer of the inner tape. DENSOLEN®-090 acts as mechanical protection layer for the corrosion prevention tape located on the inside.

Both DENSOLEN® tapes can be processed efficiently with the **DENSOMAT® wrapping devices**.

Typical product properties (Excerpt*)

Property	Unit	DENSOLEN®-032-65 AS – Typical value	DENSOLEN®-090 – Typical value	Test method
Carrier film color	-	black	yellow	-
Butyl adhesive color inside	-	grey	grey	-
Butyl adhesive color outside	-	black	-	-
Tape thickness	mm	≥ 0.65	≥ 0.4	-
Carrier film thickness app.	mm	≥ 0.18	≥ 0.26	ISO 4591
Inside adhesive layer thickness app.	mm	≥ 0.39	≥ 0.14	ASTM D1000
Outside adhesive layer thickness app.	mm	≥ 0.08	-	-
Operating temperature	°C (°F)	-40 to +50 (-40 to +122)		-
Elongation at break	%	≥ 550	≥ 400	DIN 30672
Tape strength	(+23°C/+73°F) N/cm	≥ 50	≥ 35	EN 12068
Dielectric strength	kV / mm	-	-	ASTM D149

Property	Unit	DENSOLEN® System 4 – Typical value		Test method
Specific electrical insulation resistance	$\Omega \text{ m}^2$	$\geq 10^{10}$		EN 12068
Peel strength	on steel	(+23°C/+73°F)	≥ 15	EN 12068
		(+50°C/+122°F)	≥ 2	EN 12068
		(+23°C/+73°F)	≥ 10	EN 12068
Peel strength layer to layer	on PE	032-65 AS / 032-65 AS	≥ 22	EN 12068
		032-65 AS / 090	≥ 22	
		090 / 090	≥ 2	
Indentation resistance (residual layer thickness)	(+23°C/+73°F) mm (10 MPa)	≥ 0.8		EN 12068
Impact resistance	J	≥ 15		EN 12068
Cathodic disbondment resistance	mm	< 2		EN 12068
Lap shear strength on steel	N / cm ²	≥ 8		EN 12068
System design	Primer	DENSOLEN®-HT Primer		-
	Inside tape	DENSOLEN®-032-65 AS, 2 Lagen		
	Tensioning tape	DENSOLEN®-032-65 AS, 3 Lagen		
	Outside tape	DENSOLEN®-090, 2 Lagen		
Total thickness	mm	≥ 4.1		-

* For further product information as well as details on ordering and packaging, please refer to the product data sheet at denso-group.com.

DENSOLEN® System 5 & System 6

DENSOLEN®-032-65 AS/-R20 HT

Robust two-tape field-joint coating system for the corrosion prevention of pipelines and pipeline components.

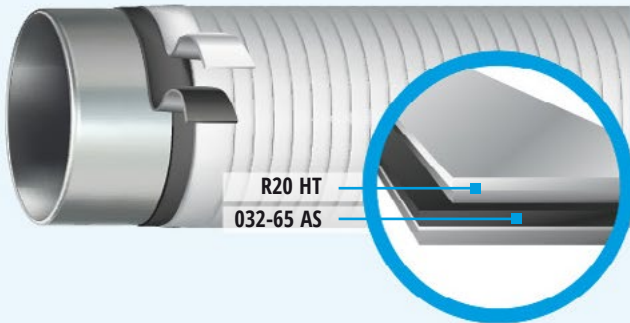

For temperatures from -50°C (-58°F) to +50°C (+122°F).



High cost effectiveness.



Modular systems: fulfill stress class B 50 in accordance with EN 12068 and ÖNORM B 5250.



Modular systems: fulfill stress class C 50 in accordance with EN 12068 and ÖNORM B 5250.

DENSOLEN® System 5 and **DENSOLEN® System 6** are field-joint encasement systems for the permanent corrosion prevention of buried pipelines and pipeline components.

DENSOLEN® System 5 and DENSOLEN® System 6 consist **modularly** of the corrosion prevention tape **DENSOLEN®-032-65 AS** and the mechanical protection tape **DENSOLEN®-R20 HT**. Depending on the number of tape layers of the outside tape, the stress classes B or C of EN 12068 are achieved.

Based on this **modular design**, these identical DENSOLEN® tapes can be used to establish the **technically and economically optimal system** in accordance with the requirements of the construction project.

DENSOLEN® System 6 features an ÖVGW approval for stress class C 50 in accordance with EN 12068 and ÖNORM B 5250.

Standard designation:

- EN 12068 - B 50 & C 50
- ÖNORM B 5250 - B 50 & C 50



DENSOLEN®-032-65 AS as the inner tape, assumes the major corrosion prevention properties of the system. **DENSOLEN®-032-65 AS** is a **co-extruded 3-ply tape** with an **asymmetrical layer design**. This design with a relative thin tape thickness of 0.65 mm provides nevertheless a thick butyl rubber coating on the pipe surface and therefore it provides an **outstanding adhesive connection even if the pipe surface is uneven**. Due to the butyl rubber layer at the upper side of the tape, a self-amalgamation effect will be achieved in the overlapping area and an essentially gas and watertight as well as electrically high insulating encasement will be created. The low tape thickness results also in a good processability at pipe elbows and fittings.

DENSOLEN®-R20 HT is a robust two-ply tape. The solid polyethylene outside layer protects the encasement against mechanical stresses.

Both DENSOLEN® tapes can be processed efficiently with the **DENSOMAT® wrapping devices**.

Typical product properties (Excerpt*)

Property	Unit	DENSOLEN®-032-65 AS – Typical value	DENSOLEN®-R20 HT – Typical value	Test method
Carrier film color	-	black	white, black or blue	-
Butyl adhesive color inside	-	grey	black	-
Butyl adhesive color outside	-	black	-	-
Tape thickness	mm	≥ 0.65	≥ 0.5	-
Carrier film thickness app.	mm	≥ 0.18	≥ 0.3	ISO 4591
Inside adhesive layer thickness app.	mm	≥ 0.39	≥ 0.2	ASTM D1000
Outside adhesive layer thickness app.	mm	≥ 0.08	-	-
Operating temperature	°C (°F)	-40 to +50 (-40 to +122)		-
Elongation at break	%	≥ 550	≥ 500	DIN 30672
Tape strength (+23°C/+73°F)	N/cm	≥ 50	≥ 65	EN 12068
Dielectric strength	kV / mm	-	≥ 50	ASTM D149

Property	Unit	DENSOLEN® System 5 – Typical value	DENSOLEN® System 6 – Typical value	Required value		Test method	
				Class B	Class C		
Specific electrical insulation resistance	Ω m²	≥ 10 ¹⁴	≥ 10 ¹⁴	≥ 10 ⁸	≥ 10 ⁸	EN 12068	
Peel strength	on steel	(+23°C/+73°F)	≥ 15	≥ 15	≥ 4	≥ 10	EN 12068
		(+50°C/+122°F)	≥ 2	≥ 2	≥ 0,4	≥ 1	EN 12068
Peel strength	on PE	(+23°C/+73°F)	≥ 10	≥ 10	≥ 2	≥ 4	EN 12068
		032-65 AS / 032-65 AS	≥ 22	≥ 22	≥ 8	≥ 15	EN 12068
Peel strength layer to layer	R20 HT / R20 HT	≥ 3	≥ 3	≥ 2	≥ 2	EN 12068	
Indentation resistance (residual thickness)	(+23°C/+73°F) (10 MPa)	mm	≥ 0.6	≥ 0.6	≥ 0.6 (1 MPa)	≥ 0.6 (10 MPa)	EN 12068
Impact resistance	J	≥ 10	≥ 15	≥ 8	≥ 15	EN 12068	
Cathodic disbondment resistance	mm	< 2	< 2	< 20	< 20	EN 12068	
Lap shear strength on steel	N / cm²	≥ 8	≥ 8	≥ 5	≥ 5	EN 12068	
System design	Primer	DENSOLEN®-HT Primer		-	-	-	
	Inner tape	DENSOLEN®-032-65 AS		-	-	-	
	Outer tape	2 layers	2 layers	-	-	-	
Total thickness	mm	DENSOLEN®-R20 HT		-	-	-	
		2 layers	3 layers	-	-	-	
Stress class	-	B 50	C 50	-	-	EN 12068	

* For further product information as well as details on ordering and packaging, please refer to the product data sheet at denso-group.com.

Your job is too hard
to have a badly protected
weld seam.

DENSOLEN®



Only **DENSOLEN®** protects like **DENSOLEN®**. The only corrosion prevention tape with 40 years' proven durability. Extremely resilient. Easy to process – using **DENSOMAT®** wrapping machines.

denso-group.com

DENSOLEN® Protection for Eternity



DENSIT®

Insulation & Sealing Tapes

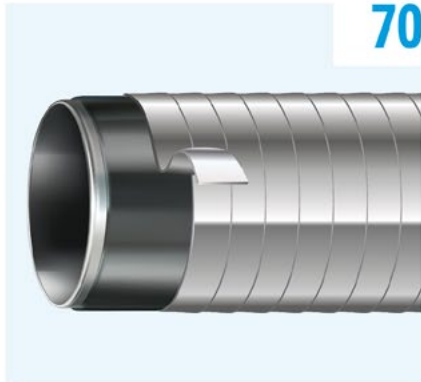

70

DENSIT®-AL, -PB

DENSIT®-AL or -PB is used as permanent UV protection and insulation on above ground pipelines and pipe bridges and it provides them an attractive silver glossy (DENSIT®-AL) or matt grey (DENSIT®-PB) surface optic.



72

DENSIT®-Alltape, -Anker, -PE100

DENSIT®-Alltape and DENSIT®-Anker are available in multiple colors and find their applications in industrial and commercial use for insulating, bundling, marking, sealing, and many more.

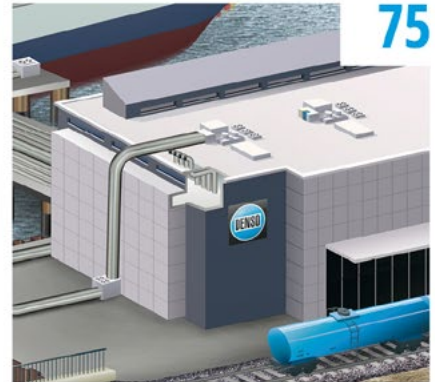

75

DENSIT®-FK, -K, -RW120

Based on their sealing, vibration damping and insulation properties, DENSIT®-FK, -K and -RW120 have found a large variety of application options in metal-structure and industry insulation.

DENSIT[®]-AL/-PB

Self-adhesive butyl rubber tapes with a laminated highly tear-resistant aluminum film for the sealing and insulation of above ground applications, e.g. on pipe bridges or for soil to air interface areas.



For temperatures from -30°C (-22°F) to +80°C (+176°F).



UV resistant.



Lowers the surface temperature by reflecting the sunlight.



Highly tear resistant.



Highly adhesive butyl rubber coating for optimal adhesion to different substrates.

DENSIT[®]-AL and **DENSIT[®]-PB** are self-adhesive butyl rubber plastic tapes with laminated, polyester reinforced highly tear resistant aluminum film in silver gloss (DENSIT[®]-AL) of matt grey (DENSIT[®]-PB) design. The highly adhesive coating made from butyl rubber **adheres very well to all common materials and surfaces**. Therefore, the surfaces, edges, folds and other transitions will be completely covered and optimally sealed.

DENSIT[®]-AL and DENSIT[®]-PB are **UV resistant** and **diffusion resistant** against water vapor and oxygen.

Due to its metallic gloss, DENSIT[®]-AL and DENSIT[®]-PB reflect the solar radiation and therefore lower the surface temperature of the coating material. This means that the **service life of the encasement material** of pipelines can be **significantly increased** especially in very warm countries with intensive sun radiation. Due to their metallic colors, DENSIT[®]-AL and DENSIT[®]-PB are also qualified for optically unobtrusive above grounds applications, e.g., on pipe bridges or soil to air interface area.

DENSIT[®]-AL and DENSIT[®]-PB are compatible with factory coatings made of PE, PP, FBE, PU, CTE and Bitumen.

DENSIT[®]-AL and DENSIT[®]-PB can be used in combination with all DENSOLEN[®] 3-ply tapes (e.g. DENSOLEN[®]-AS40 Plus) as corrosion prevention layer.

In addition, petrolatum tapes (DENSO[®]-Plast, DENSO[®]-Feu and DENSO[®]-Cal) can also be used as corrosion prevention layer.

In addition to the wrapping of corrosion prevention systems in pipeline construction, DENSIT[®]-AL and DENSIT[®]-PB can also be used for the corrosion prevention of pipe and cable brackets, for the antenna and chimney construction, for sheet metal paneling and sheet metal connections for roofs and buildings, in windows construction, for the installation and repair of gutters as well as for glass roofs, for green-houses and dome lights.

DENSIT[®]-AL and DENSIT[®]-PB must be applied with at least 25 mm tape overlap. A clean, dry and grease free surface must be provided before the application. Careful work is required in case of sharp edges or chamfers to prevent damages to the film.

Typical product properties (Excerpt*)

Property	Unit	Typical value
Thickness	mm	≥ 0.6
Weight per unit area	g / m ²	app. 10 ¹⁵
Tensile strength	N / cm	33
Peel strength on steel (90°, 100 mm / min)	N / cm	≥ 4
Water vapor permeability	g / m ² pro 24 h	< 1
Operating temperature	°C (°F)	-30 (-22) to +80 (+176)
Processing temperature (Environment, tape, surface)	°C (°F)	0 (+32) to +40 (+104)
Resistant against	-	Weather, frost, water, UV
Not permanently resistant against	-	Oil, benzine, organic solvents

* For further product information as well as details on ordering and packaging, please refer to the product data sheet at denso-group.com.

DENSIT[®]-AL6

Thin, universally-deployable aluminum sealing tape with high adhesion.

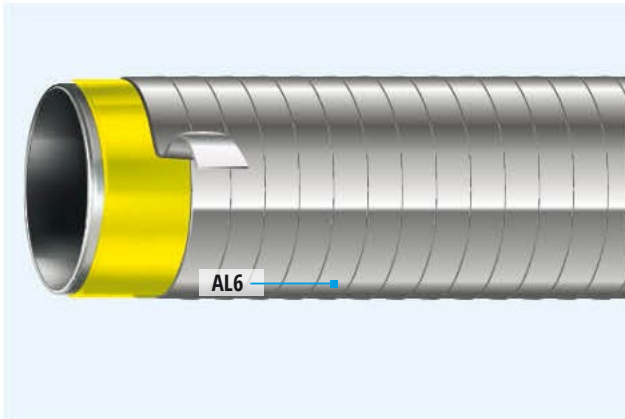

For temperatures from -30°C (-22°F) to +110°C (+230°F).



Ideally suited to sealing work on thermal insulation and ventilation ducting.



Optimal adhesion on a range of substrates.



UV-resistant.



Reflects light and heat.

DENSIT[®]-AL6 is a soft aluminum foil tape that is coated with an acrylic adhesive and contains a release film made from siliconized paper. DENSIT[®]-AL6 is impermeable to water vapor and oxygen, and resistant to UV radiation.

One use for DENSIT[®]-AL6 is as a **UV protective tape for PE-coated pipes** – an application specifically recommended by Gaz de France (FR).

In addition, DENSIT[®]-AL6 is also ideally suited for **sealing** aluminum-laminated insulation on **ventilation ducting** and pipelines

Typical product properties (Excerpt*)

Property	Unit	Typical value
Thickness	mm	0.06
Color	-	aluminium
Traction resistance	N / cm	≥ 18
Elongation after fracture	%	≥ 5
Adhesion on steel	N / cm	≥ 5
Adhesion Layer/layer	N / cm	≥ 5
Operating temperature	°C (°F)	-20 to +110 (-4 to +230)
Application temperature	°C (°F)	0 to +50 (+32 to +122)

* For further product information as well as details on ordering and packaging, please refer to the product data sheet at denso-group.com.

DENSIT[®]-Alltape

PVC insulation and multi-purpose universal tape for industrial and commercial use.

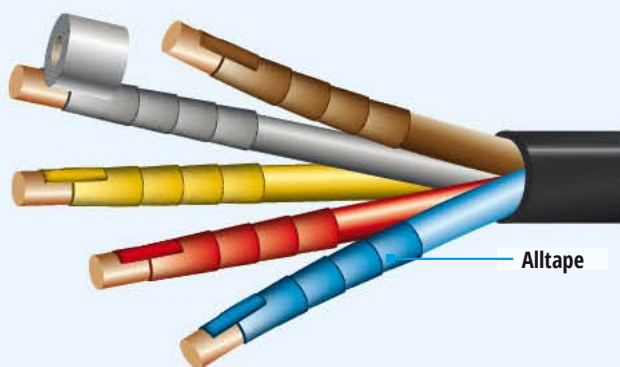

For temperatures from -20°C (-4°F) to +85°C (185°F).



High dielectric strength.



Flexible and adaptable.



Excellent adhesion on many surfaces.



Available in 11 colors.

DENSIT[®]-Alltape is a universal insulation and multi-purpose tape consisting of a PVC carrier film with a rubber adhesive coating.

DENSIT[®]-Alltape is practical for many industrial and commercial applications, such as electrical insulation and sealing of ventilation pipelines (spiral ducting). DENSIT[®]-Alltape is **easily worked** with even **at low temperatures** and is characterized by its large application temperature range of -20°C (4°F) to +85°C (+185°F).

DENSIT[®]-Alltape is naturally ideally suited for work involving insulation, bundling, bonding, marking and sealing, etc.

DENSIT[®]-Alltape is available in **11 colors** and a wide variety of dimensions.

Typical product properties (Excerpt*)

Property	Unit	Typical value
Thickness	mm	0.2 (app.)
Color	-	blue, brown, yellow, green, grey, Isogenopak grey, orange, red, black, violet, white
Tensile strength	N / cm	≥ 15
Elongation at break	%	≥ 100
Adhesive strength to steel	N / cm	≥ 0.5
Adhesive strength layer/layer	N / cm	≥ 1.0
Dielectric strength	KV / mm	≥ 25
Operating temperature	°C (°F)	-20 (-4) to +80 (+176)
Application temperature	°C (°F)	-15 to +50 (+5 - +122)

* For further product information as well as details on ordering and packaging, please refer to the product data sheet at denso-group.com.

DENSIT[®]-Anker

PVC insulation and multi-purpose universal tape with self-extinguishing carrier film for industrial and commercial use.

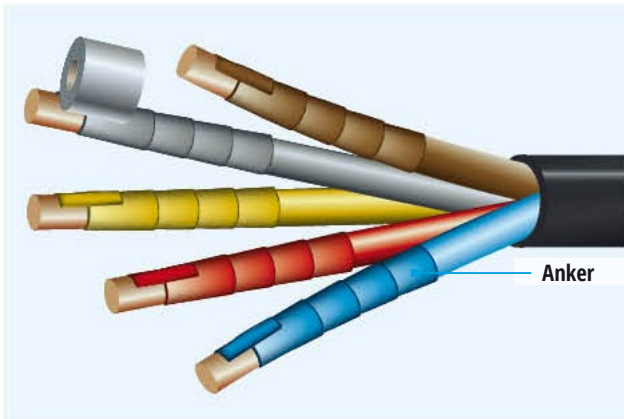

For temperatures from 0°C (+32°F) to +90°C (+194°F).



Self-extinguishing carrier film.



High dielectric strength.



Excellent adhesion on many surfaces.



Available in 11 colors.

DENSIT[®]-Anker is a universal insulation and multi-purpose tape consisting of a PVC carrier film with a rubber adhesive coating.

DENSIT[®]-Anker has a tape thickness of just 0.15 mm, making it **highly flexible and adaptable**.

DENSIT[®]-Anker is the ideal choice for a great many industrial and commercial applications, including those that involve insulation, bundling, bonding, marking, sealing, etc.

DENSIT[®]-Anker remains thermally stable at temperatures as high as +90°C (+194°F).

DENSIT[®]-Anker is available in **11 colors** and a wide variety of dimensions.

Typical product properties (Excerpt*)

Property	Unit	Typical value
Thickness	mm	0.15 (app.)
Color	-	blue, brown, yellow, green, grey, Isogeno-grey, orange, red, black, white,
Traction resistance	yellow/green (earthing)	≥ 30
Elongation after fracture	%	≥ 170
Adhesion on steel	N / cm	≥ 1.8
Adhesion layer/layer	N / cm	≥ 1.8
Dielectric strength	kV / mm	≥ 40
Operating temperature	°C (°F)	0 (+32) to +80 (+176)
Application temperature	°C (°F)	-5 to +70 (+23 - +158)

* For further product information as well as details on ordering and packaging, please refer to the product data sheet at denso-group.com.

DENSIT[®]-PE100

PE insulation and multi-purpose universal tape for industrial and commercial use.

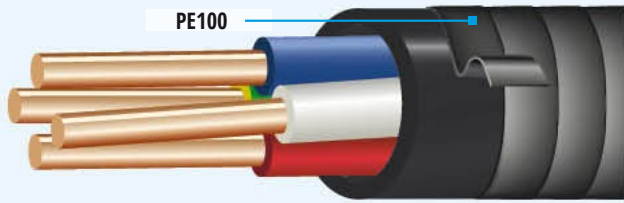

For temperatures from -50°C (-58°F) to +70°C (+158°F).



Halogen-free.



High electrical resistance and dielectric strength.



High bond strength on many surfaces.



UV-stabilized (black).

DENSIT[®]-PE100 is a universal insulation and multi-purpose tape consisting of a PE carrier film with a rubber adhesive coating.

With a tape thickness of 0.15 mm, DENSIT[®]-PE100 is **highly flexible and tear-resistant**.

DENSIT[®]-PE100 is especially suited for sealing and electrical isolation work. In addition, DENSIT[®]-PE100 is also characterized by its **excellent adhesion both to metal and plastic surfaces**.

DENSIT[®]-PE100 can be used as an additional layer of protection for coatings using **DENSO[®]** petrolatum tapes.

Typical product properties (Excerpt*)

Property	Unit	Typical value
Thickness	mm	0.15
Color	-	black, grey
Tear resistance	N / cm	≥ 18
Elongation after fracture	%	≥ 300
Adhesion on PE	N / cm	≥ 2.0
Adhesion on steel	N / cm	≥ 3.5
Volume resistivity	Ω • m	≥ 10 ¹³
Dielectric strength	kV / mm	≥ 70
Operating temperature	°C (°F)	-30 (-22) to +70 (+158)
Application temperature	°C (°F)	+10°C to +40°C (+50 to +104)

* For further product information as well as details on ordering and packaging, please refer to the product data sheet at denso-group.com.

DENSIT[®]-FK/-K and -RW120

Self adhesive, plastic insulation and sealing tapes on butyl rubber basis. Also available as a red tape (DENSIT[®]-RW120), a variant especially for railway constructions (fulfills DB-TL 91863).



For temperatures from -50°C (-58°F) to +80°C (+176°F).



Electrically highly insulating.



Galvanic isolation.



Especially high adhesive force without pre-treatment of the surface or primer.



Vibration damping.



Highly tear resistant.

DENSIT[®]-FK features a laminated thin polyethylene film on the opposite side. In contrast to DENSIT[®]-K, the DENSIT[®]-FK is only adhesive on one side and therefore ideal for the use on free surfaces.

DENSIT[®]-K is a self-adhesive plastic insulation and sealing tape made from adaptable butyl rubber, single side installation adhesive and a release layer. DENSIT[®]-K is adhesive on both sides and is therefore ideal for the use between metal parts.

DENSIT[®] tapes are used as intermediate layer between metal surfaces of the same or different type or construction parts made from other materials. Based on their **high electrical resistance, they prevent the generation of galvanic elements between components made from different metals.**

DENSIT[®]-FK, -K and RW120 are qualified for the

- Sealing of surfaces of metals of the same or different type in heating and cooling systems.
- Sealing of sheet metal ducts, riveted sheet metal packs as well as connections at corrugated spiral pipes in air conditioning and ventilation systems.
- Sealing of connections for prefabricated construction parts made from metal, plastic, glass and other materials.
- Sealing and corrosion prevention at chassis parts and other design elements in the automotive and mobile home construction.
- Sealing of components for the electrical separation of construction elements made from different materials, e.g. steel and aluminum or steel and copper or brass, e.g. in the shipbuilding and air-craft industry.
- Sealing of shed roofs and facades.
- Corrosion protecting and sealing intermediate layer in wagon and container construction.

DENSIT[®]-RW120 is especially qualified for the sealing against moisture and for the corrosion prevention of components at rail-road cars, which are connected force-fit through screw connections.

Typical product properties (Excerpt*)

Property	Unit	Typical value	Test method
Processing temperature	Environment	-10 to +70 (+14 to +158)	-
	Metal surface	0 to +50 (+32 to +122)	-
	Tape	0 to +50 (+32 to +122)	-
Operating temperature	°C (°F)	-50 to +80 (-58 to +176)	-
Equivalent air layer thickness	m	2200	DIN 52615
Dielectric strength	kV/mm	≥ 35	DIN 53481
Specific electrical insulation resistance	Ω m ²	≥ 10 ⁶	DIN 53482
Heat resistance at +120°C (+248°F)		Mastic does not drip	DB-TL 91863 (DENSIT [®] -RW120)
Heat pressure test		Mastic swells less than 2 mm out, no excretion at lower edge	
Low temperature resistance		Cracks do not occur	
Adhesive capability low temperature resistance		Intermediate layer adheres strongly	
Resistance to:			
- Diluted acids		resistant	-
- Diluted lyes		resistant	-
- Salt solutions, sea water		resistant	-
- Fungus, soil bacteria		resistant	-
Petroleum ether and other aliphatic and aromatic hydrocarbons		Durable for short term contact, not durable in case of permanent storage.	-

* For further product information as well as details on ordering and packaging, please refer to the product data sheet at denso-group.com.



PALIMEX®

Protection and Ventilation Tapes

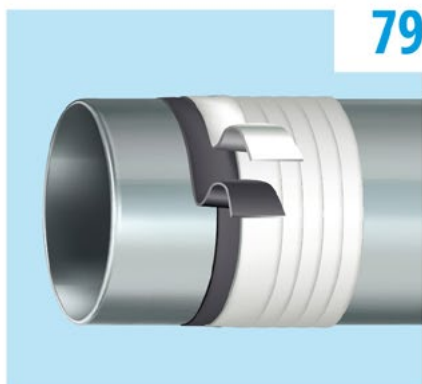

PALIMEX® Protective Tapes

Used individually or combined as a tape system, the economical PALIMEX® Protective Tapes provide permanent and reliable protection. Thanks to their variable tape thickness, they guarantee optimal adaption to parts with complex geometries.

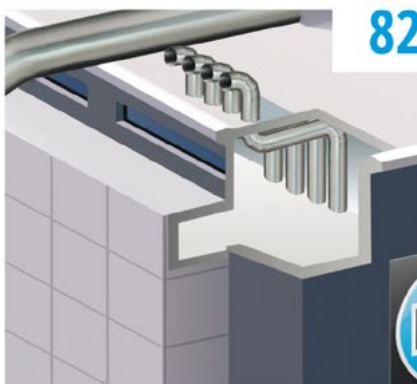

PALIMEX® Ventilation Tapes

With exceptional workability, adhesive strength and sealing effect, PALIMEX® Ventilation Tapes set a new standard in air-conditioning and ventilation technology. Thanks to their pleasing appearance, they can also be used in visible areas.

PALIMEX®-HT Primer

Solvent-based primer for PALIMEX® tapes and tape systems.

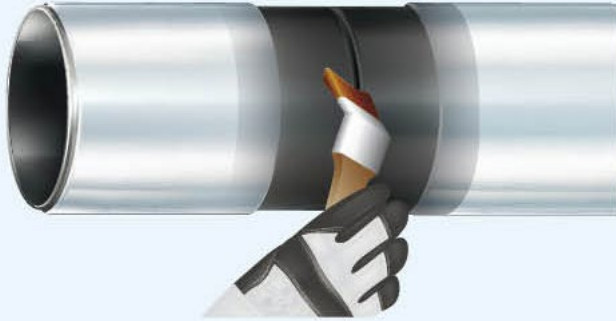

For temperatures from -60°C (-76°F) to +100°C (+212°F).



Outstanding resistance against cathodic disbondment.



For steel and other metal surfaces.



Dries fast and is easy to apply.



Compatible with factory coatings made of PE, PP, FBE, PU, CTE and bitumen.



For application with roller or brush.

PALIMEX®-HT Primer is applied to the metal surface and the adjacent factory coating before PALIMEX® tape is wrapped around the area requiring protection.

The product is an integral component of the **PALIMEX®-880/-855 tape system**. PALIMEX®-HT Primer is based on butyl rubber dissolved in naphtha (petroleum spirit). This solution is combined with resins to ensure **perfect adhesion** of PALIMEX® tapes to the treated surface.

PALIMEX®-HT Primer significantly improves resistance to cathodic disbondment and boosts the peel strength of the PALIMEX® tape system, both on the metal surface and on the factory coating.

The surface must be cleaned (surface cleanliness ST2 or SA2.5 in accordance with ISO 8501-3) and dried before PALIMEX®-HT Primer is applied. PALIMEX®-HT Primer can be applied with a brush or a roller.

PALIMEX®-HT Primer is a **high-yield product** with a **short drying time**. Coverage is around 0.2 litres per m² for a thin coating.

The drying time is approximately 5 to 10 minutes depending on the ambient temperature, air movement and air moisture.

Product processing:

Please refer to the separate **PALIMEX®-880/-855** application instructions.

Typical product properties (Excerpt*)

Property	Unit	Typical value	Test method	
Solvent	-	petroleum spirit	-	
Density	(+23°C/+73°F)	g/cm ³	0.79	DIN 51757
Solids content	wt%	30	ISO 1515	
Aromatics content	wt%	< 0.0005	-	
Drying time for manual application ¹⁾	min (app.)	5 to 10	-	
Maximum waiting time before PALIMEX® tape application	h	< 8	-	
Consumption	l/m ²	0.2	-	
Operating temperature	°C (°F)	-60 to +50 (-76 to +122)	-	

¹⁾ Depending on the temperature, humidity, air movement and surface temperature of the pipe.

* For further product information as well as details on ordering and packaging, please refer to the product data sheet at denso-group.com.

PALIMEX®-855

Robust outer protection tape for demanding mechanical applications.

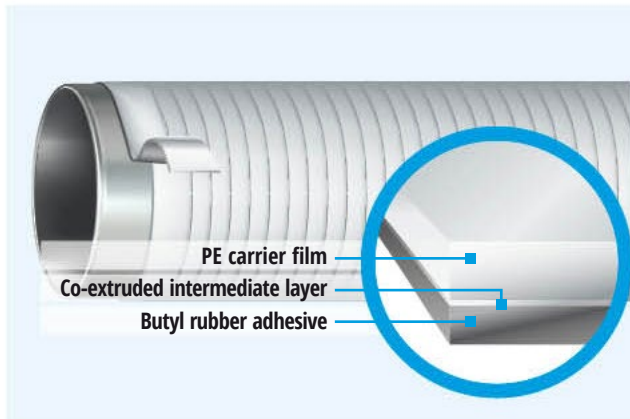

For temperatures from -50°C (-58°F) to +85°C (+185°F).



Excellent mechanical resistance.



Non-permeable to corrosive media.



UV-resistant.



Highly economical.

PALIMEX®-855 is a protective tape for the permanent protection of buried steel and cast iron pipelines in demanding mechanical applications. The tape is ideal for use as an outer tape.

The **co-extruded** two-layer plastic tape is comprised of a stabilised polyethylene carrier material and a butyl rubber coating.

PALIMEX®-855 is **UV-resistant** and **diffusion-resistant** against water vapour and oxygen. The white tape reflects sunlight while the components are stored above ground, which helps to reduce the surface temperature of the coating material. This significantly reduces the thermal load on the interior tape, particularly in very warm climates with intense sunlight.

The innovative design ensures that the tape is **strong and impact-resistant**.

PALIMEX®-855 can withstand even the highest mechanical loads.

PALIMEX®-855 is available in a range of thicknesses, allowing you to achieve optimum technical and economical results tailored to the requirements of your construction project. Suitable tape thicknesses can be combined for easy adjustment to your component dimensions, including around bends and moulded parts

For even more efficient application, the tape can be applied with **DENSOMAT® wrapping devices**.

Typical product properties (Excerpt*)

Property	Unit	PALIMEX®-855 – Typical value			Test method
		855-20	855-25	855-30	
Colour of carrier film	-	white, black, yellow			-
Butyl adhesive colour	-	black			-
Tape thickness	mm	≥ 0.51	≥ 0.63	≥ 0.76	ISO 4593
Carrier film thickness app.	mm	≥ 0.35	≥ 0.48	≥ 0.50	ISO 4593
Inside adhesive layer thickness app.	mm	≥ 0.16	≥ 0.15	≥ 0.26	ISO 4593
Elongation at break*	%	≥ 600			EN 12068
Tape strength*	N / cm	≥ 130			EN 12068
Peel resistance, layer to layer (+23°C/+73°F) *	N / cm	≥ 4			EN 12068
Operating temperature	°C (°F)	-40 to +50 (-40 to +122)			-

* Values for tape thickness 0.76 mm (type 855-30).

* For further product information as well as details on ordering and packaging, please refer to the product data sheet at denso-group.com.

PALIMEX®-880

Robust inner protection tape for demanding mechanical applications

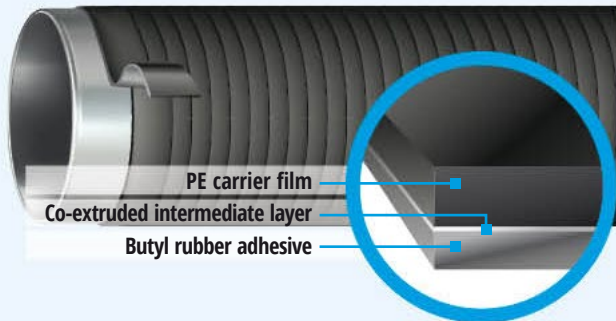

For temperatures from -50°C (-58°F) to +85°C (+185°F).



Excellent mechanical resistance.



Non-permeable to corrosive media.



Highly economical.

PALIMEX®-880 is a protective tape system for the permanent protection of buried steel and cast iron pipelines. The tape was developed as an economical solution with strong adhesion and high mechanical strength.

The **co-extruded** two-layer plastic tape is comprised of a stabilised polyethylene carrier material and a thick butyl rubber coating.

The innovative design ensures that the tape is **strong and impact-resistant**. PALIMEX®-880 can withstand even the highest mechanical loads.

The thick butyl rubber coating ensures that the surface to be protected is **thoroughly coated**.

PALIMEX®-880 is available in a range of thicknesses, allowing you to achieve optimum technical and economical results tailored to the requirements of your construction project.

Suitable tape thicknesses can be combined for easy adjustment to your component dimensions, including around bends and moulded parts

For even more efficient application, the tape can be applied with **DENSOMAT® wrapping devices**.

Typical product properties (Excerpt*)

Property	Unit	PALIMEX®-880 – Typical value			Test method
		880-20	880-25	880-30	
Colour of carrier film	-		black, yellow		-
Butyl adhesive colour	-		black		-
Tape thickness	mm	≥ 0.51	≥ 0.63	≥ 0.76	ISO 4593
Carrier film thickness app.	mm	≥ 0.25	≥ 0.30	≥ 0.30	ISO 4593
Inside adhesive layer thickness app.	mm	≥ 0.26	≥ 0.33	≥ 0.46	ISO 4593
Elongation at break*	%		≥ 50		EN 12068
Tape strength*	N / cm		≥ 80		EN 12068
Peel resistance, layer to layer (+23°C/+73°F) *	N / cm		≥ 20		EN 12068
Operating temperature	°C (°F)		-40 to +50 (-40 to +122)		-

* Values for tape thickness 0.76 mm (type 880-30).

* For further product information as well as details on ordering and packaging, please refer to the product data sheet at denso-group.com.

PALIMEX®-880/-855

Robust protective tape system for permanent protection of steel and cast iron pipelines.

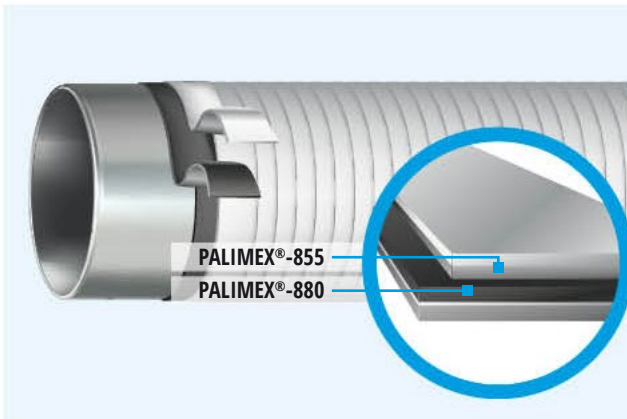

For temperatures from -50°C (-58°F) to +85°C (+185°F).



High degree of mechanical resistance.



Non-permeable to corrosive media.



Modular system.



Highly economical.

PALIMEX®-880/-855 is a protective tape system for the permanent protection of buried steel and cast iron pipelines.

PALIMEX®-880/-855 is a modular system comprised of the **interior tape**

PALIMEX®-880 and the **exterior tape PALIMEX®-855**.

Both the interior and exterior tapes are double-layered with a PE carrier film and a butyl adhesive layer on one side.

The flexible modular system allows you to combine tapes of different thicknesses to create the perfect technical and economical solution for your building project.

PALIMEX®-880/-855 forms a highly insulating coating sheath around the pipe.

Suitable tape thicknesses can be combined for easy application even around bends and moulded parts.

PALIMEX®-880 was developed to guarantee strong adhesion and outstanding flexibility on surfaces treated with PALIMEX®-HT Primer.

PALIMEX®-855 is a robust two-layer tape. The solid, **UV-resistant** polyethylene outside layer protects the encasement against mechanical stresses.

For even more efficient application, both PALIMEX® tapes can be used with **DENSOMAT® wrapping devices**.

Typical product properties (Excerpt*)

Property	Unit	PALIMEX®-880 – Typical value			PALIMEX®-855 – Typical value		
		880-20	880-25	880-30	855-20	855-25	855-30
Colour of carrier film	-	black, yellow			white, black or yellow		
Butyl adhesive colour, inside	-	black			black		
Tape thickness	mm	≥0.51	≥0.63	≥0.76	≥0.51	≥0.63	≥0.76
Carrier film thickness app.	mm	≥ 0.25	≥ 0.30	≥ 0.30	≥ 0.35	≥ 0.48	≥ 0.50
Inside adhesive layer thickness app.	mm	≥ 0.26	≥ 0.33	≥ 0.46	≥ 0.16	≥ 0.15	≥ 0.26
Elongation at break*	%	≥ 500			≥ 600		
Tape strength*	N / cm	≥ 80			≥ 130		

*Values for tape thickness 0.63 mm in accordance with DIN EN 12068.

PALIMEX®-880/ -855 with PALIMEX®-HT Primer

Property	Unit	PALIMEX®-880-25/ 855-25 – Typical value	Test method
Peel resistance metal / primer / tape	(+23°C/+73°F) N / cm	10	EN 12068
Indentation resistance (residual layer thickness)	mm	≥ 1.30	EN 12068
Impact resistance	J	≥ 14	EN 12068
Operating temperature	°C (°F)	-40 to +50 (-40 to +122)	

* For further product information as well as details on ordering and packaging, please refer to the product data sheet at denso-group.com.

PALIMEX®-170

PVC insulation and multi-purpose universal tape for industrial and commercial use.

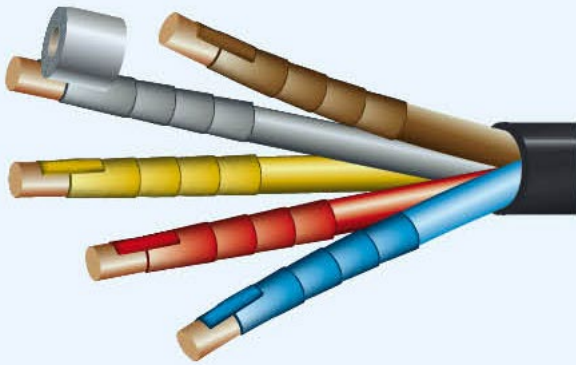

For temperatures from -20°C (-4°F) to +85°C (185°F).



High dielectric strength.



Flexible and adaptable.



Excellent adhesion on many surfaces.



Available in 10 colors.

PALIMEX®-170 is a universal insulation and multi-purpose tape consisting of a PVC carrier film with a rubber adhesive coating.

PALIMEX®-170 is practical for many industrial and commercial applications, such as electrical insulation and sealing of ventilation pipelines (spiral ducting). PALIMEX®-170 is **easily worked** with even **at low temperatures** and is characterized by its large application temperature range of -20°C (-4°F) to +85°C (+185°F).

PALIMEX®-170 is naturally ideally suited for work involving insulation, bundling, bonding, marking and sealing, etc.

PALIMEX®-170 is available in **10 colors** and a wide variety of dimensions.

Typical product properties (Excerpt*)

Property	Unit	Typical value
Thickness	mm	0.2 (app.)
Color	–	blue, brown, yellow, green, grey, Isogenopak grey, orange, red, black, white
Tensile strength	N / cm	≥ 15
Elongation at break	%	≥ 100
Adhesive strength to steel	N / cm	≥ 0.5
Adhesive strength Layer/layer	N / cm	≥ 1.0
Dielectric strength	KV / mm	≥ 25
Application temperature	°C (°F)	-15 to +50 (+5 to +122)
Operating temperature	°C (°F)	-20 bis +80 (-4 bis +176)

* For further product information as well as details on ordering and packaging, please refer to the product data sheet at denso-group.com.

PALIMEX®-2000

Co-extruded, 3-ply butyl rubber tape (cold-shrink tape) for use in sealing ventilation pipes.

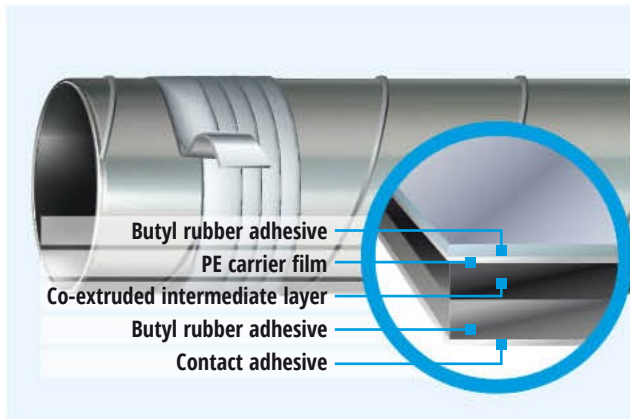

For temperatures from -40°C (-40°F) to +75°C (+167°F).



Reliable sealing at up to 5000 Pa overpressure.



Fire rating 2, non-drip.



UV-stabilized. Can be painted over.



Suited to visible installation, due to appealing silver-grey appearance.

PALIMEX®-2000 is a genuine **co-extruded 3-ply sealing tape** with a butyl rubber coating on both sides and an inner polyethylene carrier film. Thanks to its 3-ply design, PALIMEX®-2000 adheres very well in the overlapping area and forms a dense coating. As an installation aid, PALIMEX®-2000 is equipped with a pressure-sensitive adhesive coating that ensures a quick and reliable bond to many substrates such as PVC, PE, steel and galvanized sheeting.

PALIMEX®-2000 is also characterized by **outstanding tape flexibility** and a **very large** service temperature range. Thanks to its great strength and high elastic recovery, PALIMEX®-2000 enables bonding between flexible aluminum pipes and spiral ducting (e.g.) without screw fasteners being required.

On account of these characteristics, PALIMEX®-2000 is ideally suited for sealing work in HVAC applications, both in new construction projects and for retroactive sealing work.

Due to its silver-grey appearance, PALIMEX®-2000 is camouflaged in the metallic color of the ventilation pipes, which also makes it ideally suited for visible installations. Reducers, screw fittings and pipe junctions can also be wrapped without any folds. In applications where a metallic finish is not desirable, PALIMEX®-2000 can be painted with many industry-standard paints.

Typical product properties (Excerpt*)

Property	Unit	Typical value	Test method
Tape thickness	mm	≥ 0.63	-
Outer layer thickness	mm	≥ 0.03	-
Carrier film thickness	mm	≥ 0.08	-
Butyl rubber coating thickness	mm	≥ 0.46	-
Pressure-sensitive adhesive thickness	mm	≥ 0.06	-
Tensile strength	N/cm	≥ 10	DIN 30672
Elongation at break	%	≥ 500	DIN 30672
Building material class	-	B2 (normally inflammable)	DIN 4102-1
Fire rating	-	E (normally inflammable, non-drip)	EN ISO 11925-2
Working temperature	°C (°F)	-15 to +50 (+5 to +122)	-
Operating temperature	°C (°F)	-40 to +50 (-40 to +122)	-

* For further product information as well as details on ordering and packaging, please refer to the product data sheet at denso-group.com.

PALIMEX®-KTB 500

Co-extruded, 2-ply butyl rubber tape (cold-shrink tape) for use in sealing ventilation pipes.

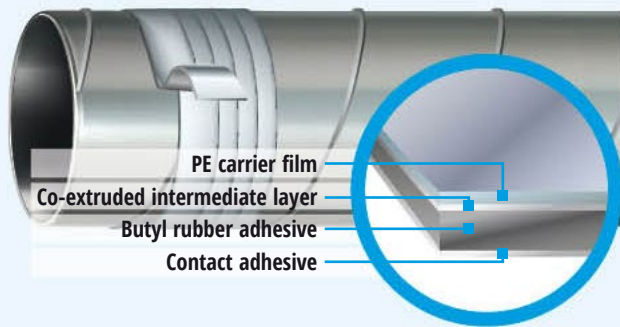

For temperatures from -50°C (-58°F) to +75°C (+167°F).



Reliable sealing at up to 3500 Pa overpressure.



Highly stable PE carrier film, silicon-free and solvent-free.



Fire rating 2, non-drip.



UV-stabilized.



Suited to visible installation, due to appealing silver-grey appearance.

PALIMEX®-KTB 500 is a genuine **co-extruded 2-ply sealing tape** with a butyl rubber coating on a polyethylene carrier layer.

As an installation aid, PALIMEX®-KTB 500 is equipped with a pressure-sensitive adhesive coating that ensures a quick and reliable bond to many substrates such as PVC, PE, steel and galvanized sheeting.

PALIMEX®-KTB 500 is also characterized by **outstanding tape stability** and a **very large service temperature range**.

On account of these characteristics, PALIMEX®-KTB 500 is ideally suited for sealing work in HVAC applications, both in **new construction projects and for retroactive sealing work**.

Unlike many standard adhesive tapes, PALIMEX®-KTB 500 is installed with a pre-stretch of about 10%. The subsequent elastic recovery of the tape causes the tape to wrap itself tightly around the butt joint to be sealed, causing the formation of an airtight joint with no folds.

Due to its silver-grey appearance, PALIMEX®-KTB 500 is camouflaged in the metallic color of the ventilation pipes, which also makes it ideally suited for visible installations. Reducers, screw fittings and pipe junctions can also be wrapped without any folds.

Typical product properties (Excerpt*)

Property	Unit	Typical value	Test method
Tape thickness	mm	≥ 0.45	-
Carrier film thickness	mm	≥ 0.10	-
Butyl rubber coating thickness	mm	≥ 0.30	-
Pressure-sensitive adhesive thickness	mm	≥ 0.05	-
Tear resistance	N/cm	≥ 20	DIN 30672
Elongation after fracture	%	≥ 150	DIN 30672
Building material class	-	B2 (normally inflammable)	DIN 4102-1
Fire rating	-	E (normally inflammable, non-drip)	EN ISO 11925-2
Working temperature	°C (°F)	-5 to +50 (+41bis +122)	-
Operating temperature	°C (°F)	-40 to +50 (-40 to +122)	-

* For further product information as well as details on ordering and packaging, please refer to the product data sheet at denso-group.com.



PALIMEX®

PALIMEX®-880/-855.

Pipeline protection, simply economical.

The new two-tape system **PALIMEX®-880/-855** reliably protects your pipeline – and saves your budget. Developed to withstand heavy mechanical loads, impermeable to corrosive media. Both tapes guarantee optimum adaptation to components with complex geometries thanks to variable tape thicknesses.

denso-group.com

 **made in
Germany**
since 1922



DEKOTEC®

Heat Shrinkable Sleeves

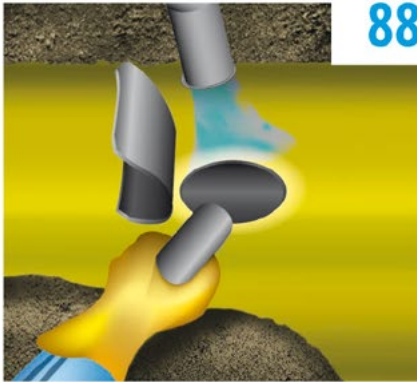

88

DEKOTEC® Repair Materials

System solution for the user friendly repair of damages at anti-corrosion coatings. DEKOTEC® repair materials assume afterwards again completely the function of the factory coating at operating temperatures of up to +90°C (+194 °F).



90

DEKOTEC®-BTS

Innovative sleeve that is quick and easy to apply: blast cleaning and surface preheating are not required. It regenerates itself: Minor damage to the sleeve backing compensates for itself through the flowability of the special butyl rubber.



91

DEKOTEC®-HTS

The HTS product series provides high quality and robust sleeves for the protection of welding seams against corrosion as two and three-layer systems for normal and high operating temperatures. The high quality is represented by the many approvals of internationally recognized operating companies and certification bodies.



94

DEKOTEC®-MTS

The MTS product series is applied as a two-layer system directly on the steel surface (ST 2) without extensive preheating. The advantages are found in the easy and fast application, which provides a significantly more cost-effective application.

DEKOTEC®-EP Primer/ EP Primer HT

Two component thick layer epoxy resin primer for three-layer DEKOTEC®-HTS heat shrinkable sleeve systems.

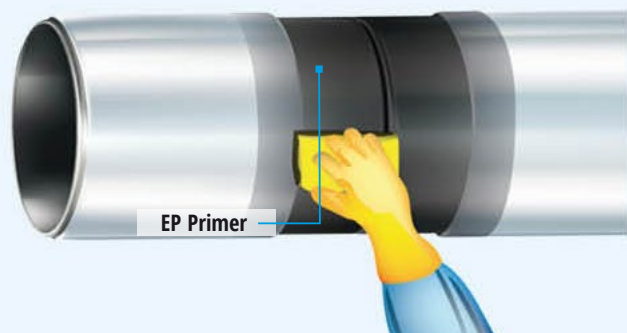

For temperatures from -50°C (-58°F) to +130°C (+266°F).



Outstanding cathodic disbondment resistance.



Dries fast and is easily processed.



For manual and machine application.



Compatible with factory coatings made of PE, PP, FBE, PU, CTE and bitumen.

DEKOTEC®-EP Primer/ -EP Primer HT are epoxy primer for DEKOTEC® shrink sleeve systems. Apply primers easily and manually with film thicknesses up to more than 200µm in just one work step.

In combination with **DEKOTEC®-HTS** shrink sleeves, the primer achieves an outstanding 3-layer corrosion protection coating which fulfils all requirements class C of EN 12068 and DIN 30672. Of course, the requirements of ISO 21809-3, Type 14B are also fulfilled.

The very good cathodic disbondment resistance guarantees the highest safety and durability of the corrosion protection coating. Thanks to the heat-assisted curing of the DEKOTEC® Primer, the pipe surface is optimally prepared for the application of the DEKOTEC®-HTS shrink sleeve. The different packaging sizes available, always offer you an economical and application-friendly solution.

Typical product properties (Excerpt*)

Eigenschaft	Einheit	Typical value	
		DEKOTEC®-EP Primer	DEKOTEC®-EP Primer HT
Type	-	two components, solvent-free	
Color	-	black	
Recommended minimum layer thickness	µm	30	200
Mixing ratio (according to weight/according to volume)	-	132:50 / 100:50	100:28,25 / -
Pot life (+23°C/ +73,4°F)	min	app. 20	
Theoretical consumption for 100 µm DFT	kg / m ²	0.121	0.144
Operating Temperature	°C (°F)	-50 to +90 (-58 to +194)	-50 to +100 (-58 to +212)

* For further product information as well as details on ordering and packaging, please refer to the product data sheet at denso-group.com.

DEKOTEC®-DRP, -Filler & -Meltstick

Hot applied repair system for corrosion prevention coatings of pipes and pipelines.

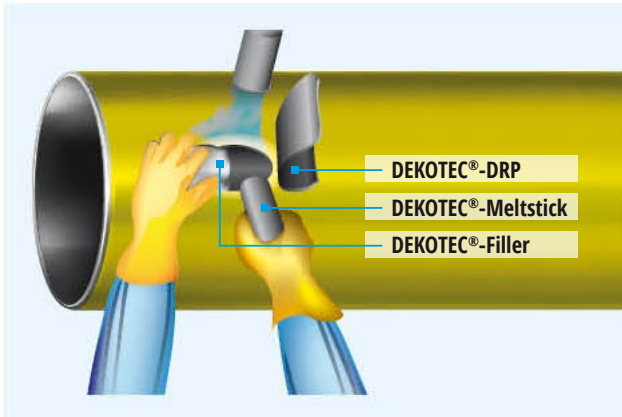

For temperatures from -40°C (-40°F) to +90°C (+194°F).



Fulfills EN 12068-C HT 60 and DIN 30672-C HT 60.



Fulfills the high-temperature aging standard ASTM D638 (168h at +150°C (+302 °F)).



Compatible with factory coatings made of PE, PP, FBE, PU and Bitumen.



Easy to apply manually.

DEKOTEC®-DRP, -Filler and Meltstick are products for the repair of damages of corrosion prevention coatings of pipes and pipelines.

DEKOTEC®-DRP, -Filler and -Meltstick are parts of a hot applied system, which is especially economical. It guarantees a **high quality of the repairing of factory coatings**.

DEKOTEC®-Meltstick is a heat activated adhesive, produced in bars, for the easy filling of defects. DEKOTEC®-Filler can be used also to remove damages in the factory or field-joint coating.

DEKOTEC®-DRP is made of electron beam cross-linked polyethylene backing and a coating of heat activated adhesive copolymers.

DEKOTEC®-DRP, -Filler and -Meltstick system can be applied **quickly without special tools**.

The applied system offers an optimal protection of the pipelines against moisture and corrosion. It is resistant against the abrasion and the peeling forces during the installation and the operation of pipes and pipelines.

After application it assumes the function of the factory coating.

Beyond the classification of DIN 30672 and EN 12068, **DEKOTEC®-DRP** can be used for permanent operating temperatures up to +90°C (194°F). In this case, the mechanical properties at temperatures of +90°C (+194°F) are lower than the characteristics of the use at +60°C (+140°F).

Typical product properties (Excerpt*)

Property	Unit	Typical value	Test method	
Adhesive	Softening point	°C (°F)	≥ +110 (≥ +230)	ASTM E28
	Lap shear strength	(+23°C/+73°F) (+80°C/+176°F) N/cm ²	≥ 350 ≥ 6	EN 12068 DIN 30672
Backing	Elongation at break	%	≥ 500	ASTM D638
	Tensile strength	MPa (psi)	≥ 20 ≥ 20 (2900)	EN 12068 ASTM D638
	Dielectric strength	kV / mm	≥ 35	ASTM D149
	Volume resistivity	Ω · cm	≥ 10 ¹⁵	ASTM D257
	Hardness	Shore D	≥ 55	ISO 868 ASTM D2240
Specific electrical insulation resistance	Ω · m ²	≥ 10 ¹⁰	EN 12068	
Indentation resistance*	(+23°C/+73°F) mm	≥ 2.5	EN 12068	
Impact resistance*	J	≥ 25	EN 12068	
System	Peel strength on factory coating	(+23°C/+73°F) N / cm	≥ 60	EN 12068
	Low temperature flexibility		passed	EN 12068 ASTM D2671(-20°C/-4°F)
	Cathodic disbondment resistance (radius)	mm	< 2	ASTM G8
	Water absorption	%	≤ 0.06	ASTM D570
Operating temperature	°C (°F)	-40 to +90 (-40 to +194)	-	

*With 2mm DEKOTEC®-Meltstick as filling

* For further product information as well as details on ordering and packaging, please refer to the product data sheet at denso-group.com.

DEKOTEC®-BTS60

Butyl sleeve with self-healing properties for corrosion prevention for weld seams on steel pipes.

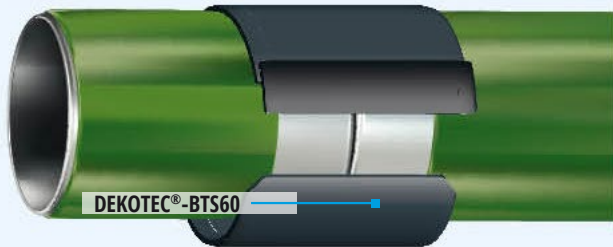

For temperatures from -40°C (-40°F) to +70°C (+158°F).



Fulfills EN 12068-C HT 60 and DIN 30672 T1, even on an unblasted surface without preheating.



Fulfills ISO21809-3, Type 14A-2, even on an unblasted surface without preheating.



No primer required.



Compatible with factory coatings made of PE, PP, FBE, PU and bitumen.

DEKOTEC®-BTS60 is a heat shrinkable sleeve with thermal indicator that lets you visually check the amount of heat to be applied. It comprises of a robust electron beam cross-linked polyethylene carrier film and a butyl-based coating.

Special inhibitors and the outstanding structural integrity of DEKOTEC®-BTS60 guarantee **permanent corrosion protection and a long service life** for your components.

The 2-layer coating system DEKOTEC®-BTS60 is applied to the surface cleaned in accordance with ISO8501-1. The optionally recommended use of DENSOLEN®-HT Primer guarantees the best possible and verifiable surface treatment. This also allows random checking of the results of the application by a peel test after only a few hours.

The requirements for shrinkable sleeves in EN 12068, DIN 30672 and ISO 21809-3 are already exceeded with a surface cleanliness of ST2 (manual rust removal).

In particular, the minimal surface preparation, **no complex blast cleaning and no preheating** required, underline the economic efficiency. The flowability of the special butyl rubber coating also gives the product self healing properties for minor mechanical damage to the casing.

DEKOTEC®-BTS60 fulfills all requirements of DIN EN 12068 and DIN 30672, Class C HT 60 for operating temperatures of up to +60°C (+140°F).

DEKOTEC®-BTS60 also fulfills the necessary test values pursuant to ISO 21809-3 Type 14A-2 for shrinkable sleeves for operating temperatures of up to +60°C (+140°F).

Typical product properties (Excerpt*)





Property	Unit	Typical value	Test method
Sleeve thickness on delivery	mm	≥ 2.6	ISO 4593
Indentation resistance (10 MPa) (residual layer thickness)	(+23°C/+73°F) (+60°C/+140°F)	mm 1.2 1.0	EN 12068
Impact resistance	J	≥ 15	EN 12068
Peel strength on pipe surface	(+23°C/+73°F) (+60°C/+140°F)	N/cm 16 5	EN 12068
Peel strength on PE factory coating	(+23°C/+73°F) (+60°C/+140°F)	N/cm 16 5	EN 12068
Lap shear strength	(+23°C/+73°F) (+60°C/+140°F)	N/cm² 12 8	EN 12068
Elongation at break	%	≥ 500	EN 12068
Tear resistance	N/mm	≥ 20	EN 12068
Dielectric strength	kV/mm	≥ 35	ASTM D149
Hardness	Shore D	55	ISO 868/ASTM D2240
Specific electrical insulation resistance	Ω·m²	≥ 10 ¹¹	EN 12068
Water absorption	%	< 0.06	ASTM D570
Chemical resistance 24 h storage at (+23°C/+73°F)	-	0.1 n NaOH 0.1 n Na ₂ SO ₄ 0.1 n H ₂ SO ₄ 0.1 n HCl	
Operating temperature	°C (°F)	-40 to +60 (-40 to +140)	-

* For further product information as well as details on ordering and packaging, please refer to the product data sheet at denso-group.com.

DEKOTEC®-HTS70

Hotmelt sleeve for high-load conditions for protecting welded seams on steel pipes against corrosion.



-  For temperatures from -40°C (-40°F) to +80°C (+176°F).
-  Three-layer system equivalent to 3LPE.
-  Fulfills EN 12068-C HT 60 and DIN 30672-C HT 60.
-  Fulfills ISO 21809-3, Type 14B-1.
-  Lower preheating temperature than comparable competitive products.
-  Outstanding peel strength and lap shear strength.
-  Approval a.o. by Gaz de France (France), Enagás (Spain) and GOST R (Russia).

DEKOTEC®-HTS70 is a heat shrinkable sleeve made of an electron beam cross-linked polyethylene backing and a coating made from hot melt adhesive.

DEKOTEC®-HTS70 provides a permanent corrosion prevention on welding seams at steel pipes and pipelines.

DEKOTEC®-HTS70 can be used as **two-layer** or **three-layer** heat shrinkable sleeve system together with the **DEKOTEC®-EP Primer**. Both systems have **DIN-DVGW certificates** for stress **class C 60 UV** in accordance with DIN EN 12068 (Reg.-No.: NV-5180 BR0224).

The surface preparation with DEKOTEC®-EP Primer provides an increased safety against failed applications and an increased protection in case of damages to the encasement.

DEKOTEC®-HTS70 is compatible with factory coatings made of PE, PP, FBE, PU and Bitumen.

The performance of **DEKOTEC®-HTS70** is shown internationally in many usages as well as the **high number of certifications** by DVGW (Germany), Gaz de France (France), Enagás (Spain), SVGW (Switzerland) and Synergrid (Belgium), as well as GOST R (Russia).



Beyond the standard classification, DEKOTEC®-HTS70 can be used for permanent operating temperatures of **up to +70°C (+158°F)**.

For higher operating temperatures, with **DEKOTEC®-HTS90 +90°C (+194°F)** and **DEKOTEC®-HTS100 +100°C (+212°F)**, additional high quality shrink sleeves are available. **DEKOTEC®-MTS55** and **DEKOTEC®-BTS60 (+60°C/+140°F)** as well as **DEKOTEC®-MTS30 (+30°C/+86°F)** are cost effective alternatives for lower temperature requirements.

Typical product properties (Excerpt*)

DEKOTEC®-HTS70 with DEKOTEC®-EP Primer

Property		Unit	Typical value	Test method
Adhesive	Softening point	°C (°F)	> +90 (> +194)	ASTM E28
	Lap shear strength	(+23°C/+73°F)	≥ 275	EN 12068 DIN 30672
		(+60°C/+140°F)	≥ 15	
Backing	Elongation at break	%	> 500	EN 12068
	Tensile strength	N/mm	> 20	EN 12068
		MPa (psi)	> 20 (2900)	ASTM D638
	Dielectric strength	kV / mm	> 35	ASTM D149
	Volume resistivity	Ω cm	≥ 10 ¹⁵	ASTM D257
	Hardness	Shore D	≥ 55	ISO 868 / ASTM D2240
	Elongation at break after thermal aging (21 days at +150°C/302°F)	%	> 500	ASTM D638
	Lap shear strength after thermal aging (21 days at +150°C/302°F)	MPa	> 20	ASTM D638
	Water absorption	%	< 0.1	ASTM D570
	Specific electrical insulation resistance	Ω m ²	≥ 10 ¹⁰	EN 12068
System	Indentation resistance*	(+23°C/+73°F)	> 2	EN 12068
		(+60°C/+140°F)	> 2	
	Impact resistance*	J	≥ 17	EN 12068
	Peel strength on pipe surface	(+23°C/+73°F)	≥ 100	EN 12068
		(+60°C/+140°F)	≥ 2.5	
	Peel strength on PE factory coating (+23°C/+73°F)	N / cm	≥ 100	EN 12068
Cathodic disbondment resistance (radius)	mm	< 2	ASTM G8	
Operating temperature	°C (°F)	-40 to +70 (-40 to +158)	-	

* The listed values are based on a sleeve thickness of 2.6 mm (type 5).

*** For further product information as well as details on ordering and packaging, please refer to the product data sheet at denso-group.com.**

DEKOTEC®-HTS90

Hotmelt sleeve with high temperature resistance for protecting welded seams on steel pipes against corrosion.



- For temperatures from -40°C (-40°F) to +100°C (+212°F).
- Three-layer system equivalent to 3LPE.
- Fulfills EN 12068-C HT 80 UV and DIN 30672-C HT 80 UV.
- Approvals in accordance with GOST R.
- Outstanding peel strength.
- Lower preheating temperature than comparable competitive products.

DEKOTEC®-HTS90 is a heat shrinkable sleeve made of an electron beam cross-linked polyethylene backing and a coating made from hot melt adhesive.

DEKOTEC®-HTS90 provides a permanent corrosion prevention on welding seams at steel pipes and pipelines.

DEKOTEC®-HTS90 can be used as **two-layer** heat shrinkable sleeve system, or together with **DEKOTEC®-EP Primer**, as a **three-layer** heat shrinkable sleeve system. Both systems have **DIN-DVGW certificates for the stress class C 80 UV** in accordance with DIN EN 12068 (Reg.- No.: 5180BS0064, NG-5180BS0065). In addition, DEKOTEC®-HTS90 has an approval in accordance with GOST R 51164-98 (Russia).

The three-layer system consisting of DEKOTEC®-EP Primer and DEKOTEC®-HTS90 provides an increased protection in case of damages to the encasement as well as an increased safety against failed applications based on the surface preparation with the DEKOTEC®-EP Primer.

DEKOTEC®-HTS90 is compatible with factory coatings made of PE, PP, FBE, PU and Bitumen.

Beyond the standard classification, DEKOTEC®-HTS90 can be used for permanent operating temperatures of **up to +90°C (+194°F)**.

For lower temperature requirements, **DEKOTEC®-HTS70** (+70°C/+158°F), **DEKOTEC®-MTS55** and **DEKOTEC®-BTS60** (+60°C/+140°F) as **DEKOTEC®-MTS30** (+30°C/+86°F) are available as high quality and cost effective alternatives.

Typical product properties (Excerpt*)

DEKOTEC®-HTS90 with DEKOTEC®-EP Primer

Property		Unit	Typical value	Test method
Adhesive	Softening point	°C (°F)	> +110 (> +230)	ASTM E28
	Lap shear strength	(+23°C/+73°F)	≥ 275	EN 12068 DIN 30672
		(+80°C/+176°F)	≥ 6	
Backing	Elongation at break	%	>500	EN 12068
	Tensile strength	N/mm	> 20	EN 12068
		MPa (psi)	> 20 (2900)	ASTM D638
	Dielectric strength	kV / mm	> 35	ASTM D149
	Volume resistivity	Ω cm	≥ 10 ¹⁵	ASTM D257
	Hardness	Shore D	≥ 55	ISO 868 / ASTM D2240
	Elongation at break after thermal aging (21 days at +150°C/302°F)	%	> 500	ASTM D638
	Lap shear strength after thermal aging (21 days at +150°C/302°F)	MPa	> 20	ASTM D638
	Water absorption	%	< 0,1	ASTM D570
	Specific electrical insulation resistance	Ω · m ²	≥ 10 ¹⁰	EN 12068
System	Indentation resistance*	(+23°C / +73°F)	≥ 2	EN 12068
		(+80°C/+176°F)	≥ 1	
	Impact resistance*	J	≥ 20	EN 12068
	Peel strength on pipe surface	(+23°C / +73°F)	> 65	EN 12068
		(+80°C/+176°F)	≥ 2	
	Peel strength on PE factory coating (+23°C/+73°F)	N / cm	≥ 50	EN 12068
Cathodic disbondment resistance (radius)	mm	< 8,5	EN 12068	
Operating temperature	°C (°F)	-40 to +90 (-40 to +194)	-	

* The listed values are based on a sleeve thickness of 2.6 mm (type S).

*** For further product information as well as details on ordering and packaging, please refer to the product data sheet at denso-group.com.**

DEKOTEC®-HTS100

Hot-melt sleeve with extreme temperature resistance for protecting welded seams on steel pipes against corrosion.

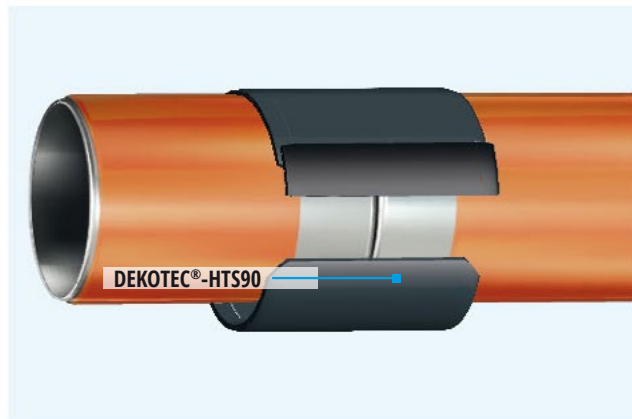

For temperatures from -40°C (-40°F) to +120°C (+248°F).



Excellent lap shear strength and resistance to cathodic disbondment.



Fulfils EN12068-C100 and DIN 30672-C100.



Fulfils ISO21809-3, Type 14B-2.



Resistant to abrasion and chemicals.



Compatible with the most common factory coatings.

DEKOTEC®-HTS100 is a heat-shrinkable sleeve with thermal indicator that allows you to visually check the amount of heat to be applied. It is comprised of a ro-bust electron beam crosslinked polyethylene carrier film and a hot melt coating.

Special inhibitors and the outstanding structural integrity of DEKOTEC®-HTS100 guarantee **permanent corrosion protection and a long service life** for your components.

Thanks to its special composition, it has achieved **excellent lap shear strength and cathodic disbondment resistance values** – with **outstanding adhesion properties** too.

Of course, DEKOTEC®-HTS100 has the same outstanding **resistance against abrasion and chemicals** as all products in the DEKOTEC® product family.

Thanks to the **quick, problem-free application** of the sleeve, and thanks to the low prewarming requirement, you will **save time and money** in comparison with established systems.

In combination with **DEKOTEC®-EP Primer HT** which can be applied in layer thicknesses of $\geq 200\mu\text{m}$, you can create an additional coating of equal value to a factory coating.

DEKOTEC®-HTS100 satisfies the necessary test values pursuant to ISO 21809-3, Type 14B-2 for shrinkable sleeves.

DEKOTEC®-HTS100 also satisfies all the requirements of DIN EN 12068 and DIN 30672, Class C100 for operating temperatures of up to +100°C (+212°F).

Typical product properties (Excerpt*)

Property		Unit	Typical value	Test method
Indentation resistance (10 MPa) (residual layer thickness)	+80°C/+175°F	mm	≥ 2	ISO 21809-3
	+100°C/+212°F		≥ 0.8	EN 12068
Impact resistance*	(+23°C/+73°F)	J/mm	≥ 7.2	ISO 21809-3
	(+23°C/+73°F)		≥ 50	ISO 21809-3
Peel strength on pipe surface	(+80°C/+176°F)	N / cm	≥ 5	ISO 21809-3
	+100°C / +212°F		≥ 3	EN 12068
Peel strength on PE factory coating	(+23°C/+73°F)	N / cm	≥ 60	ISO 21809-3
Cathodic disbondment resistance	(+23°C/+73°F)	mm	≤ 3	EN 12068
Lap shear strength	(+23°C/+73°F)	N/cm ²	≥ 500	ISO 21809-3
	(+80°C/+176°F)		≥ 70	
Operating temperature		°C (°F)	-40°C (-40°F) to +100°C (+212°F)	

* The listed values are based on a sleeve thickness of 2.6 mm (type S) when used with DEKOTEC®-EP Primer HT.

* For further product information as well as details on ordering and packaging, please refer to the product data sheet at denso-group.com.

DEKOTEC®-MTS30

Cost-effective mastic sleeve solution for protecting welded seams on steel pipes against corrosion.

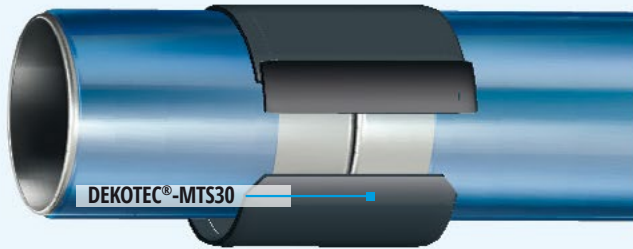

For temperatures from -35°C (-31°F) to +40°C (+104°F).



Two-layer system.



Sandblasting the steel surface and preheating are not required.



Fulfills the requirements of EN 12068-C 30 and DIN 30672-C 30.



Fulfills the requirements of ISO 21809-3; Type 14A-1.



Outstanding lap shear strength and peel strength.



Compatible with factory coatings made of PE, PP, FBE, PU and bitumen.

DEKOTEC®-MTS30 is a heat shrinkable sleeve consisting of an electron beam cross-linked polyethylene carrier film and an adhesive on the basis of a polymer-modified bitumen for the corrosion prevention of the field joints at steel pipes.

DEKOTEC®-MTS30 can be **directly applied to cleaned surfaces ST 2** in accordance with ISO 8501-1. **Sandblasting or a primer are not required.**

The combination of a robust PE carrier film with a strongly adhesive adhesion coating of the two-layer encasement system DEKOTEC®-MTS30 provides an outstanding corrosion prevention and an **easy and time-saving processing**.

*Drying of the surface with a flame is adequate.
Surface temperature (>23°C/>73°F).

Significant time and cost savings are archived and an increased safety against application mistakes is provided due to the elimination of extensive preheating process*.

DEKOTEC®-MTS30 can be used on pipes with factory coatings made of PE, PP, PU and Bitumen.

Additional heat shrinkable sleeve types are available for higher operating temperatures with **DEKOTEC®-MTS55** and **DEKOTEC®-BTS60** (+60°C/+140°F) as well as **DEKOTEC®-HTS70** +70°C (158°F), **DEKOTEC®-HTS90** +90°C (+194°F) and **DEKOTEC®-HTS100** +100°C (+212°F).

Typical product properties (Excerpt*)

	Property	Unit	Typical value	Test method
Adhesive	Softening point	°C (°F)	> +75 (>+167)	ASTM E28
	Lap shear strength	N/cm ²	> 70	EN 12068 DIN 30672
Backing	Elongation at break	%	≥ 500	EN 12068
	Tensile strength	N/mm	≥ 20	EN 12068
	Dielectric strength	MPa (psi)	> 20 (> 2900)	ASTM D638
	Volume resistivity	kV / mm	> 35	ASTM D149
	Hardness	Ω · cm	≥ 10 ¹⁵	ASTM D257
	Specific electrical insulation resistance	Shore D	≥ 55	ISO 868 / ASTM D2240
System	Indentation resistance*	Ω · m ²	≥ 10 ¹⁰	EN 12068
	Impact resistance*	mm	≥ 2	EN 12068
	Peel strength on pipe surface	J	≥ 15	EN 12068
	Peel strength on PE factory coating	N / cm	≥ 12	EN 12068
	Cathodic disbondment resistance (radius)	N / cm	≥ 12	EN 12068
	Operating temperature	mm	<3	EN 12068
		°C (°F)	-35°C to +30 (-31 to +86)	-

* Values for the sleeve thickness 2.6 mm (type S).

*** For further product information as well as details on ordering and packaging, please refer to the product data sheet at denso-group.com.**

DEKOTEC®-MTS55

All-round mastic sleeve solution for protecting welded seams on steel pipes against corrosion.



For temperatures from -35°C (-31°F) to +70°C (+158°F).



Two-layer system.



Sandblasting the steel surface and preheating are not required.



Fulfills the requirements of EN 12068-C 50 and DIN 30672-C 50.



Fulfills the requirements of ISO 21809-3; Type 14A-1.



Outstanding lap shear strength and peel strength.

DEKOTEC®-MTS55 is a heat shrinkable sleeve consisting of an electron beam cross-linked polyethylene backing and a coating on bitumen basis for the corrosion prevention of the field joints at steel pipes.

DEKOTEC®-MTS55 will be applied **directly on ST2-cleaned surfaces** in accordance with ISO 8501-1. **Sandblasting and a primer are not required.**

Due to the combination of a robust PE carrier film and a strongly adhesive adhesion coating of the two-layer encasement system **DEKOTEC®-MTS55** provides outstanding corrosion prevention and an **easy and time-saving processing.**

Significant time and cost savings are archived and an **increased safety against** application mistakes is provided due to the **elimination of the extensive preheating process***.

*Drying of the surface is adequate to meet the standard requirements. By additionally preheating the surface, peel strength values can be achieved which are well above the standard requirements.

DEKOTEC®-MTS55 can be used on pipes with factory coatings made of PE, PP, FBE, PU and Bitumen.

DEKOTEC®-MTS55 has a DIN-DVGW certificate (NV 5180C00211) for class C 50 in accordance with EN 12068. In addition, all requirements of EN 12068 and DIN 30672 of **class C** will be achieved **at operating temperatures of +55°C (+131°F).**

DEKOTEC®-MTS55 represents a reliable corrosion prevention for operating temperatures +60°C (+140°F).

If required **DEKOTEC®-MTS55** can be used together with the **DEKOTEC®-EP Primer**, which means that a three-layer coating system is achieved.

Additional heat shrinkable sleeve types are available for higher operating temperatures by using **DEKOTEC®-HTS70** +70°C (158°F), **DEKOTEC®-HTS90** +90°C (+194°F) and **DEKOTEC®-HTS100** +100°C (+212°F). **DEKOTEC®-MTS30** is an economic alternative for lower temperature requirements.

Typical product properties (Excerpt*)

Property	Unit	Typical value	Test method	
Adhesive	Softening point ring and ball	°C (°F)	> +85 (> +185)	ASTM E28
	Lap shear strength	(+23°C/+73°F)	> 100	EN 12068
		(+50°C/+122°F)	≥ 10	
Backing	Elongation at break	%	> 500	EN 12068
	Tensile strength	N/mm	> 20	EN 12068
		MPa (psi)	> 20 (2900)	ASTM D638
	Dielectric strength	kV / mm	> 35	ASTM D149
	Volume resistivity	Ω · cm	≥ 10 ¹⁵	ASTM D257
	Hardness	Shore D	≥ 55	ISO 868 / ASTM D2240
	Specific electrical insulation resistance	Ω · m ²	≥ 10 ¹⁰	EN 12068
	Indentation resistance*	(+23°C/+73°F)	mm	> 2,1
(+50°C/+122°F)		> 1,5		
Impact resistance*	J	> 15	EN 12068	
System	Peel strength on pipe surface	(+23°C/ +73°F)	> 28	EN 12068
		(+50°C/ +122°F)	≥ 2,5	
		(+55°C/ +131°F)	> 2,2	
	Peel strength on PE factory coating	(+23°C/ +73°F)	> 28	EN 12068
		(+55°C/ +131°F)	> 2,8	
Cathodic disbondment resistance (radius)	mm	< 7	EN 12068	
Operating temperature	°C (°F)	-35 to +60 (-31 to +140)	-	

* Values for the sleeve thickness 2.6 mm (type 5).

* For further product information as well as details on ordering and packaging, please refer to the product data sheet at denso-group.com.

DEKOTEC®-MTS55 DI

Mastic sleeve for protecting spigot-and-socket pipes against corrosion and root penetration.

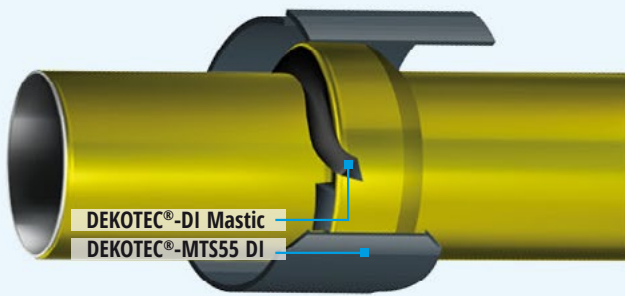

For temperatures from -35°C (-31°F) to +70°C (+158°F).



Applicable to pipes made of cast iron, steel and stoneware – without preheating.



Fulfills the requirements of EN 12068-C50



Fulfills the requirements of ISO 21809-3; Type 14A-1.



Outstanding lap shear strength and peel strength.



Reliable protection against corrosion and root penetration.

DEKOTEC®-MTS55 DI in combination with **DEKOTEC®-DI Mastic** is a sealing system solution, which provides an **outstanding protection against corrosion and root penetration** at sleeve joints **without an extensive heating process**.

DEKOTEC®-MTS55 DI is a heat shrinkable sleeve consisting of a robust electron beam cross-linked polyethylene backing and an adhesive based on polymer-modified bitumen.

DEKOTEC®-DI Mastic is an especially balanced **self-adhesive** material based on bitumen, which is simultaneously used as a **protection for existing sealings** and to **balance of the sleeve bell protrusion**. A fast and simple processing is achieved through the self-adhesive properties and the dimensioning as a triangle profile in a strand shape.

DEKOTEC®-MTS55 DI can be applied to pipes made from steel, cast iron, concrete and stoneware as well as on plastic or bitumen coatings.

Significant time and cost savings are archived and an **increased safety against application mistakes** is provided due to the **elimination of the extensive preheating process***.

DEKOTEC®-MTS55 DI fulfills all requirements of EN 12068 and DIN 30672 of Class C at operating temperatures of +55°C (+131°F) and can also be used for operating temperatures of up to +60°C (+140°F).

*Drying of the surface with a flame is adequate.
Surface temperature > +23°C (> +73°F).

Typical product properties (Excerpt*)

Property	Unit	Typical value	Test method	
Adhesive	Softening point ring and ball	°C (°F)	> +85 (+185)	ASTM E28
	Lap shear strength	N/cm ²	> 100 ≥ 10	EN 12068
Backing	Elongation at break	%	> 500	EN 12068
	Tensile strength	N/mm	≥ 20	EN 12068
	Dielectric strength	kV / mm	≥ 35	ASTM D149
	Volume resistivity	Ω · cm	≥ 10 ¹⁵	ASTM D257
	Hardness	Shore D	≥ 55	ISO 868 / ASTM D2240
	Specific electrical insulation resistance	Ω · m ²	≥ 10 ¹⁰	EN 12068
System	Indentation resistance*	mm	> 2 > 1.8	EN 12068 (10 MPa)
	Impact resistance*	J	≥ 17	EN 12068
	Peel strength on pipe surface	N / cm	> 28 > 15	EN 12068
	Peel strength on PE factor coating	N / cm	> 28	EN 12068
	Cathodic disbondment resistance	mm	< 3	EN 12068
	Operating temperature	°C (°F)	-35 to +60 (-31 to +140)	-





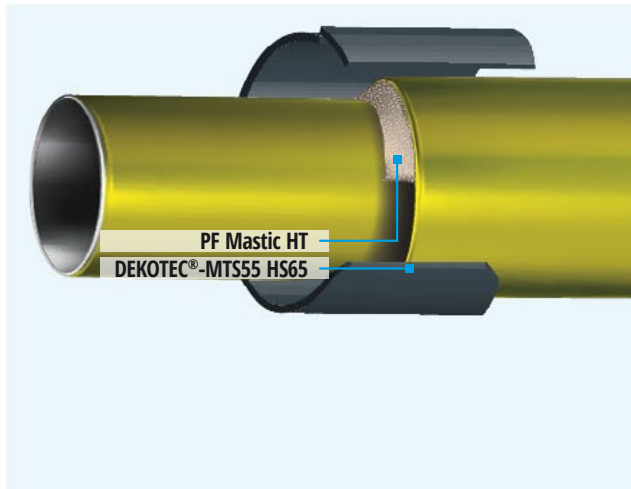

* Values for the sleeve thickness of 2.5 mm (type N)
1) For closed concrete pores when using DEKOTEC®-EP Primer.

* For further product information as well as details on ordering and packaging, please refer to the product data sheet at denso-group.com.

DEKOTEC®-MTS55 HS65

Shrink-fit sleeve for permanent corrosion protection on pipeline components with extreme variations in diameter.



-  For temperatures from -35°C (-31°F) to +70°C (+158°F).
-  Suitable for extreme variations in diameter.
-  No primer required.
-  C50
EN 12068
Fulfills the requirements of EN 12068-C 50
-  14A-2
ISO 21809-3
Fulfills the requirements of ISO 21809-3; Type 14A-2.
-  Fast and cost-effective fitting.
-  Compatible with factory coatings made of PE, PP, FBE, PU and bitumen.

DEKOTEC®-MTS55 HS65 is a heat shrinkable sleeve with **extreme shrinking capacity**. It is comprised of a robust electron beam cross-linked polyethylene carrier film and a bitumen-based coating.

The outstanding structural integrity of **DEKOTEC®-MTS55 HS65** guarantees **permanent corrosion protection and a long service life** for your components.

DEKOTEC®-MTS55 HS65 is applied directly to the surface, which is cleaned to ISO 8501-1 standards, **without a primer**.

Thanks to the **fast and simple method of applying** the sleeve to **preinstalled components** such as protective pipe ends, couplings or flanges, the system generates significant **time and cost savings**.

DEKOTEC®-MTS55 HS65 satisfies all the requirements of ISO 21809-3 Type 14A-2 for operating temperatures of up to +60°C (+140°F).

DENSO®-PF Mastic HT is another tried-and-tested, high-quality DENSO product for applications in warm climates and on components that are subject to periodic maintenance, such as screwed flanges, as well as to prevent notch effects on screw heads.

DENSO®-PF Mastic HT is ideal for smoothing irregular shaped geometries and also ensures that maintenance can be carried out without any difficulties.

Typical product properties (Excerpt*)

Property	Unit	Typical value	Test method
Sleeve thickness on delivery	mm	≥ 1.9	ISO 21809-3
Shrink rate (free shrinkage)	%	app. 65	-
Indentation resistance (10 MPa) (residual layer thickness)	mm	(+23°C/+73°F) ≥ 2.0	ISO 21809-3
		(+60°C/+140°F) ≥ 1.8	
Impact resistance	J	≥ 5	ISO 21809-3
Peel strength on pipe surface	N/cm	(+23°C/+73°F) ≥ 26	ISO 21809-3
		(+60°C/+140°F) ≥ 3	
Peel strength after 100d hot water storage (P100/P0)	Pipe surface	≥ 1.1	ISO 21809-3
	Factory coating	≥ 1.0	
Peel strength on PE factory coating	N/cm	(+23°C/+73°F) ≥ 28	ISO 21809-3
		(+60°C/+140°F) ≥ 3	
Cathodic disbondment resistance	N/cm ²	(+23°C/+73°F) ≤ 8	ISO 21809-3
Lap shear strength	N/cm ²	(+23°C/+73°F) ≥ 60	ISO 21809-3
Operating temperature	°C (°F)	-35 to +60 (-31 to +140)	-

* For further product information as well as details on ordering and packaging, please refer to the product data sheet at denso-group.com.



DENSOLID®

Polyurethane Coatings



Protection for Pipes and Fittings

The portfolio of the DENSOLID® product family includes high performance spread and spray coatings for buried pipes and components, which can be applied at the factory as well as at the construction site.

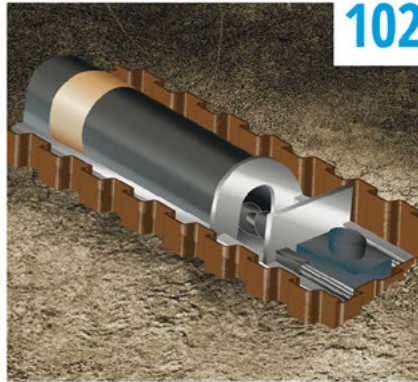

Trenchless Pipe Laying

The trenchless pipe installation places special requirements on the field-joint coating. The DENSOLID® products deliver innovative special solutions on the basis of polyurethane with a revolutionary easy and safe processing.

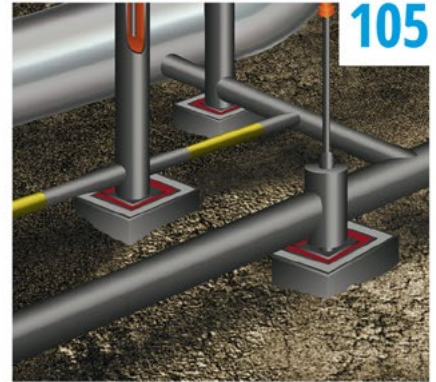

Insulation of Fittings

The DENSOLID® product family is completed by the DENSOLID®-Insulation Plate. It covers a wide application spectrum from plant and machine construction and electrics up to the use as root protection mat.



DENSOMIX® Processing Equipment

DENSOMIX® cartridge dispenser for two-component polyurethane systems permit the application of DENSOLID® products in cartridge packaging.

DENSOLID®-FK2

Polyurethane coating for corrosion prevention of buried steel pipes, armatures and containers and for Soil to air Interface Area.

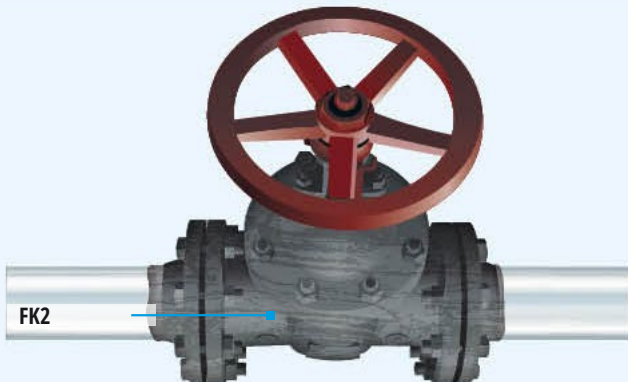

For temperatures from -40°C to +80°C (-40°F to +176°F).



Stress class B, type 3 in accordance with DIN EN 10290.



Solvent-free.



Outstanding balance of flexibility and hardness.



Can be used as factory or construction side coating.

DENSOLID®-FK2 is a two component polyurethane coating for the application by airless hot spray processes.

DENSOLID®-FK2 is outstandingly qualified for a permanent corrosion prevention of buried steel pipes, armatures and containers. DENSOLID®-FK2 is also qualified for the especially high requirements in the **area of soil to air interface** areas of pipelines.

DENSOLID®-FK2 can be used for factory coatings as well as for field coatings and therefore it can be used in the **rehabilitation area as well as for new constructions**.

The high hardness in combination with good stretchability provides a high degree of resistance against mechanical damages.

Based on these properties, DENSOLID®-FK2 is, for example, used very successfully for the renewal of corrosion prevention coatings in gas compressor stations.

DENSOLID®-FK2 fulfills the requirements of DIN 30677-2 and DIN EN 10290 (class B, type 3) and it is therefore qualified for high mechanical stresses at operating temperatures up to +80°C (+176°F).

As the coating material for smaller areas as well as for holiday repairs, DENSOLID®-FK2 C can be applied by a palette-knife and is available as a variant in practical two chamber cartridges.

Typical product properties (Excerpt*)

Property		Component A	Component B
Color		black	brown transparent
Dyn. viscosity, (mPas)	(+25°C/+77°F)	13000	160
	(+50°C/+122°F)	1500	
	(+70°C/+158°F)	300	
Density (g/cm³)		app. 1.39	app. 1.23
Mix ratio	Weight	100	36,36
	Volume	100	40,9

Property		Unit	Typical value	Test method
Impact resistance	(+23°C/+73°F)	J/mm	> 7	EN 10290
	(-5°C/+23°F)		> 3	
Indentation resistance	(+23°C/+73°F)	mm	< 0.15	EN 10290
	(+80°C/+176°F)	%	≤ 29	
Hardness	(+5°C/+41°F)	Shore D	77 ±3	ISO 868
	(+23°C/+73°F)		74 ±3	
	(+40°C/+104°F)		66 ±3	
Cathodic disbondment	(+60°C/+140°F), 2d	mm	< 6	EN 10290
Pull-off adhesion	(+23°C/+73°F)	MPa	> 16	EN 10290
	(+80°C/+176°F)		> 3	
Pull-off adhesion after thermal aging	(+100°C/+212°F), 100d	MPa	> 17	EN 10290
Adhesion (knife test)	(+23°C/+73°F)	mm	< 1	EN 10290
	(+80°C/+176°F)		< 2	
Elongation at break		%	> 15	EN 10290
Operating temperature		°C (°F)	-20 to +80 (-4 to +176)	-

* For further product information as well as details on ordering and packaging, please refer to the product data sheet at denso-group.com.

DENSOLID®-FK2 C

DENSOLID®-FK2 C Repair Compound

Two component polyurethane spread coating for the corrosion protecting coating of the buried armatures and fittings as well as for the holiday repair of anti-corrosion coatings made from PE, PP, EP, PUR.

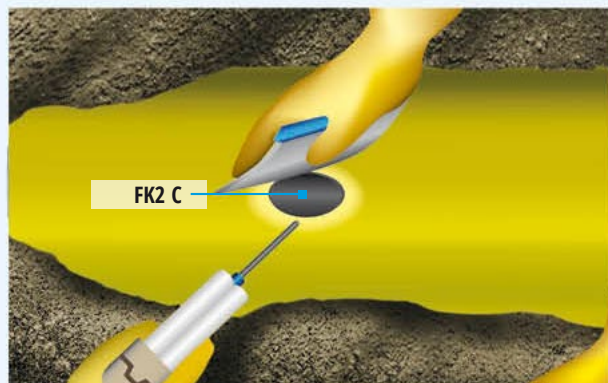

For temperatures from -40°C (-40°F) to +80°C (+176°F).



Corrosion prevention for increased requirements.



Easy and fast processing.



Can be applied by a palette-knife and without prime coat!



Fulfills the requirements in accordance with EN 10290 (class B, type 3), and DIN 30677-2.



Significantly faster in the application than traditional repair systems on the basis of melt sticks and repair patches.

DENSOLID®-FK2 C is a **two component polyurethane** corrosion prevention coating. Can be applied with a **palette-knife** or can be spread **with a brush** (only 400 ml cartridge). It is applied **without primer** on the metallic blank steel and the activated factory coating. DENSOLID®-FK2 C allows for **easy processing due to cartridge packaging**. In accordance with the requirements in accordance with EN 10290 (class B, type 3), and DIN 30677-2. The 50 ml packages is adjusted thixotropic and can therefore easily be used in the 6 o'clock position. The curing time is adapted to the package size.

Use of product:

Corrosion prevention of buried steel pipes, containers, armatures and fittings as well as the repair of defects in corrosion prevention coatings made of PE, PP, PUR and Epoxy.

Material consumption:

Range for 2 mm layer thickness:

400 ml cartridge: app. 0.175 m² | 50 ml cartridge: app. 200 cm²

Product processing:

Please adhere to the separately available processing recommendations DENSOLID®-FK2 C and DENSOLID®-FK2 C Repair Compound 50 ml.

Cartridge dispensers:

DENSOMIX®-50: Cartridge dispenser for 50 ml cartridges including 4 plastic pallet knives.

DENSOMIX®-400 M: Manual cartridge dispenser for 400 ml cartridges.

DENSOMIX®-400 P: Pneumatic cartridge dispenser for 400 ml cartridges.

Typical product properties (Excerpt*)

Property	Unit	Typical value	Test method
Impact resistance	J/mm	≥ 5	EN 10290
		≥ 3	
Indentation resistance	mm	≤ 0.1	EN 10290
		≤ 27	
Hardness	Shore D	77 +/- 5	ISO 868
		74 +/- 5	
		66 +/- 5	
		45 +/- 5	
Cathodic disbondment	mm	≤ 3.0	EN 10290
		≤ 2.5	
Adhesive strength	mm	≤ 1	EN 10290
		≤ 1	
		≥ 16	
Adhesion after thermal aging	N / mm ²	≥ 3	EN 10290
		≥ 17	
Elongation at break	%	≥ 18	EN 10290
		≥ 10 ¹⁰	
Specific electrical insulation resistance	Ω · m ²	≥ 10 ⁴	EN 10290
		≥ 10 ⁴	
Density	g/cm ³	app. 1.4	-
Layer thickness	mm	≥ 1.5 mm (FK2-C)	ISO 2808
		≥ 2.5 mm (FK2-C Repair compound)	
Stress class	-	Class B, type 3	EN 10290
Free of pores at	8 kV/mm, max 20 kV	fulfilled	EN 10290
Operating temperature	°C (°F)	-20 to +80 (-4 to +176)	EN 10290

Hardening times		+10°C (+50°F)	+20°C (+68°F)	+40°C (+104°F)
50-ml cartridge	Pot life	app. 75 sec	app. 60 sec	app. 50 sec.
	Tack-free	app. 40 min	app. 10 min	app. 5 min
	Resilient	app. 4 h	app. 2 h	app. 1.5 h
400-ml cartridge	Pot life	app. 5 min	app. 4 min	app. 3 min
	Tack-free	app. 60 min	app. 30 min	app. 25 min
	Resilient	app. 24 h	app. 8 h	app. 7 h
Processing temperature	Substrate	(≥+10°C/+50°F); min. (+3°C/+41°F) above dew point		
	Environment	(+5°C to +50°C/+41°F to +122°F)		
	Material	(+15°C to +30°C/+59°F to +86°F)		
Steel surface	Degree of cleanliness (ISO 8501-1)	min. Sa 2 ½		
	Surface roughness (ISO 8503-1)	40 - 100 µm		
Relative humidity		≤ 80%		

* For further product information as well as details on ordering and packaging, please refer to the product data sheet at denso-group.com.

DENSOLID®-HDD

Corrosion prevention system for the field joint coating of welding seams in pipelines installed using horizontal directional drilling (HDD) or the pipe-plough method.

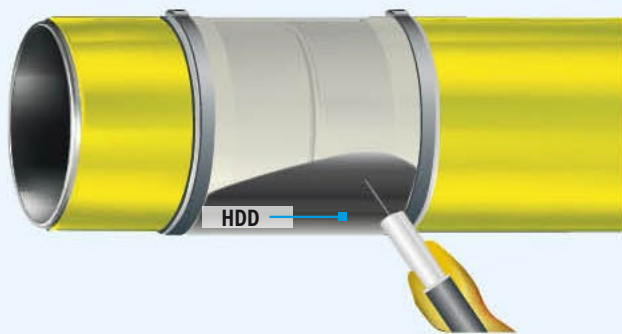

For temperatures from -40°C (-40°F) to +80°C (+176°F).



High abrasion resistance and peel resistances.



Stress class B, type 3 in accordance with DIN EN 10290.



Solvent-free.



Compatible with factory coatings made of PE, PP, PUR, PA, EP, GRP.

DENSOLID®-HDD is a two-component polyurethane coating for a permanent corrosion prevention of field-joints at pipes for trenchless installation processes.

DENSOLID®-HDD features a **high hardness and abrasion resistance** as well as **good stretchability and bending strengths**. Therefore, DENSOLID®-HDD is especially qualified for the coating of welding seams at pipes and pipelines that are installed using the horizontal directional drilling (HDD) or the **(rocket) pipe-plow** method.

The balanced property profile and the easy processing from a two-chamber cartridge have been proven outstandingly for decades in many construction projects worldwide.

The **coating** is provided from a two chamber cartridge **in one work step** in a **special casing system**. The casing system provides a **high surface quality** and also **protects the material against weather** impacts during hardening.

DENSOLID®-HDD fulfills the requirements of DIN EN 10290 (class B, type 3) for operating temperatures of up to +80°C (+176°F) and therefore it is designed for highly corrosive and highly mechanical stresses.

DENSOLID®-TLC is an additional fast hardening corrosion prevention coating on the basis of polyurethane for the field-joint coating for trenchless pipe installations in piling and pipe ramming processes.

Typical product properties (Excerpt*)

Property	Unit	Typical value	Test method	
Layer thickness	mm	> 1.5	EN 10290	
Free of pores at 8 kV / mm (max. 20 kV)	-	fulfilled	EN 10290	
Impact resistance	(+23°C/+73°F)	J/mm	> 5	EN 10290
	(-5°C/+23°F)		> 3	
Indentation resistance	(+23°C/+73°F)	mm	< 0.1	EN 10290
	(+80°C/+176°F)	%	≤ 29	
Specific electrical insulation resistance	(+23°C/+73°F), 100 d	Ω m²	> 1.5 · 10 ¹⁰	EN 10290
	(+80°C/+176°F), 30 d		> 1.0 · 10 ⁵	
Pull-off adhesion on steel	(+23°C/+73°F)	MPa	> 13	EN 10290
	(+80°C/+176°F)		> 2	
Pull-off adhesion on PE, PP	(+23°C/+73°F)	MPa	> 4	ISO 4624
Adhesive strength after water storage (+80°C/+176°F), 100 h)	(+23°C/+73°F)	mm	≤ 1 (Rating 1)	EN 10290
Cathodic disbondment	(+23°C/+73°F), 30 d	mm	< 2.5	EN 10290
	(+60°C/+140°F), 2 d		< 2.5	
Hardness	(+5°C/+41°F)	Shore D	75±3	ISO 868
	(+20°C/+68°F)		73±3	
	(+40°C/+104°F)		59±3	
	(+70°C/+158°F)		36±3	
Density	g/cm³	app. 1.3	-	
Dielectric strength	kV/mm	> 5	-	
Flexibility	(+23°C/+73°F)	-	fulfilled	EN 10290
	(0°C/+32 °F)		fulfilled	
Elongation at break	%	≥ 18	EN 10290	
Adhesive strength (knife test) on steel	(+23°C/+73°F)	mm	≤ 1 (Rating 1)	EN 10290
	(+80°C/+176°F)	mm	≤ 3 (Rating 3)	
Lap shear strength	Steel	N/cm²	> 400	EN 12068
	PE	N/cm²	> 50	
Operating temperature	°C (°F)	-20 to +80 (-4 to +176)	-	

* For further product information as well as details on ordering and packaging, please refer to the product data sheet at denso-group.com.

DENSOLID®-HK7

Mechanical protective coating for the weld seam area on plastic pipes, especially for trenchless laying techniques.

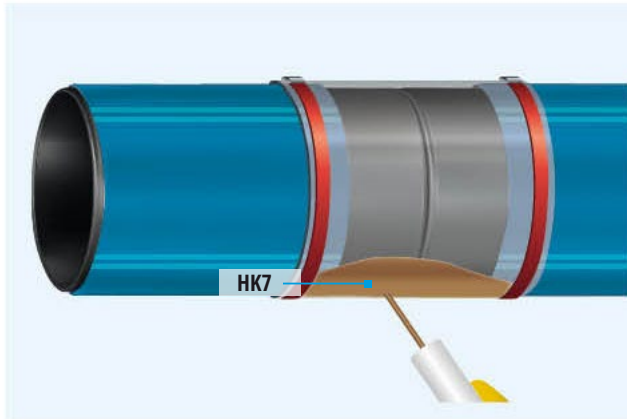

For temperatures for -40°C (-40°F) to +80°C (+176°F).



Outstanding protection of weld seams on plastic pipes.



High mechanical stability and abrasion resistance.



Simple, safe processing using two-component cartridges.



Rapid curing.

DENSOLID®-HK7 is a rapidly-curing, mechanically hard-wearing coating based on polyurethane. DENSOLID® HK7 is characterized by its high abrasion resistance and impact strength.

Thanks to these properties, DENSOLID® HK7 is ideally suited to assume the function of a protective wrapping in the weld seam area for plastic pipes with protective wrappings.

Thanks to the **use of a specialized casing system**, the cut-back of the protective wrapping in the **weld seam area is filled completely, flush to the edge**, and a **high finish** quality is achieved with the coating. Due to the smooth surface, only a truly minimal resistance is presented to the ground for trenchless laying techniques such as are used in horizontal directional drilling, for example.

DENSOLID® HK7 is processed out of practical 2-component cartridges, which guarantee a constant mixing ratio while ensuring that work can proceed cleanly and rapidly.

At low temperatures, the curing of DENSOLID®-HK7 can be accelerated with suitable heat sources.

Typical product properties (Excerpt*)

Property	Unit	Typical value	Test method	
Color	-	yellow		
Hardness	(+23°C/+73°F)	Shore D	70±3	ISO 868
Density		g/cm³	1.3 (app.)	-
Pot life	(+5°C/+41°F)	min	10 (app.)	
	(+25°C/+77°F)		3 (app.)	
	(+35°C/+95°F)		2.5 (app.)	
Hardening time	(+5°C/+41°F)	h	25	
	(+15°C/+59°F)		15	
	(+60°C/+140°F)		3	
Operating temperature	°C (°F)		-20 to +80 (-4 to +176)	-

* For further product information as well as details on ordering and packaging, please refer to the product data sheet at denso-group.com.

DENSOLID®-TLC

Corrosion prevention system for the field-joint coating of welded seams on pipelines laid using piling and pipe ramming processes.

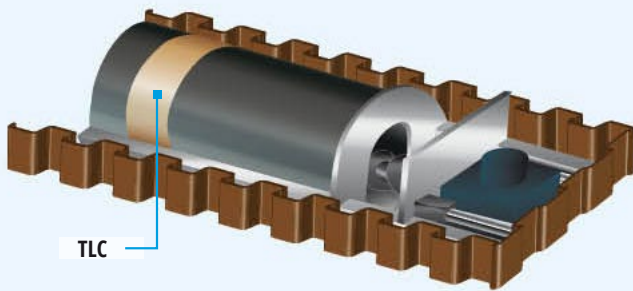

Operating temperature from -40°C (-40°F) to +80°C (+176°F)



Rapid hardening product



Stress class B, type 3 in accordance with DIN EN 10290



Solvent-free



Tested in accordance with ISO 21809-3, class 18B

DENSOLID®-TLC is a rapid-hardening two-component polyurethane coating that provides permanent corrosion prevention of welded seams on pipes laid using piling and pipe ramming processes.

In a single work step, DENSOLID®-TLC is **injected directly** from a two-chamber cartridge **into a special casing system**, enabling the user to apply the product in a wide thickness range. The casing system provides a **high surface quality and also protects the coated surface against the elements**. Additional, the user is protected against material contact. The predetermined component mixing ratio ensures that the product is **easy to apply**, with consistently high-quality results. **The system reliably eliminates the risk of mixing errors and bubble formation.**

DENSOLID®-TLC boasts a high level of mechanical resistance combined with an **exceptionally low frictional resistance**.

DENSOLID®-TLC actively helps to **reduce the force required to draw** the pipe-line into position, yet offers the same outstanding corrosion prevention properties of the DENSOLID® product series.

DENSOLID®-TLC meets the requirements of DIN EN 10290 (class B, type 3) for operating temperatures up to +80°C (+176°F), enabling it to withstand highly corrosive atmospheres and high levels of mechanical stress.

DENSOLID®-TLC is also tested in accordance with ISO 21809-3, class 18B.

DENSOLID®-TLC is compatible with PE, PP, PA, PU, GRP and EP factory coatings.

Quantity required (1.5 mm layer thickness):

app. 5 cartridges per m² of surface

Product processing:

Please refer to the separate DENSOLID®-TLC application instructions.

Cartridge dispensers:

DENSOMIX®-400M: Manual cartridge dispenser for 400 ml cartridges.

DENSOMIX®-400P: Pneumatic cartridge dispenser for 400 ml cartridges.

We hereby draw attention to another special product. **DENSOLID® HDD** is a further rapid-hardening, polyurethane-based corrosion prevention coating for the field-joint coating of welded seams in trenchless pipe installations using the HDD or pipe-plough method.

Typical product properties (Excerpt*)

Property	Unit	Typical value	
		DIN EN 10290	ISO 21809-3
Layer thickness	mm	≥ 1.5 mm	≥ 1.5 mm
Free of pores at	8 kV/mm, max 20 kV	fulfilled	fulfilled
Impact resistance	J/mm	(+23°C/+73°F)	≥ 5
		(-5°C/+23°F)	≥ 3
Indentation resistance	mm	dry, (+23°C/+73°F)	≤ 0.1
		dry, (+80°C/+176°F)	≤ 30
Specific electrical insulation resistance	Ω · m ²	(+23°C/+73°F)	≥ 10 ⁹
		(+80°C/+176°F)	≥ 10 ⁴
Adhesive strength (steel surface)	N / mm ²	(+23°C/+73°F)	≥ 12
		(+80°C/+176°F)	≥ 1.5
Adhesive strength (PE factory coating)	N / mm ²	(+23°C/+73°F)	-
		Hot water storage (+80°C/+176°F), 28 days (+23°C/+73°F)	≥ 3
Adhesion after thermal aging	(+100°C/+212°F), 100 days	N / mm ²	≥ 5
Cathodic disbondment resistance	mm	(+23°C/+73°F), 28 days	≤ 5.0
		(+60°C/+140°F), 2 days	≤ 5.0
Hardness	(+23°C/+73°F)	Shore D	≥ 75
Density			app. 1.44
Stress class	-		Class B, type 3
Operating temperature	°C (°F)		-20 to +80 (-4 to +176)

* For further product information as well as details on ordering and packaging, please refer to the product data sheet at denso-group.com.

DENSOLID®-IPL

Polyurethane Insulation Plate for the electrical insulation of pipelines and armatures.

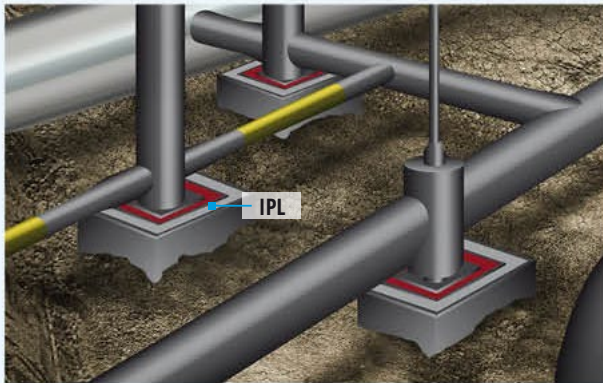

- ✓ High resilience and durability.
- ✓ High electrical resistance.
- ✓ Prevents prestressed funnel.
- ✓ Thermally and chemically durable.
- ✓ Qualified for armatures foundations, for the insulation of cable crossings and as root protection.

The **DENSOLID®-IPL** with its high electrical insulation properties, guarantees a **reliable electrical separation** between cathodic protected pipelines and foundations made from concrete. **Voltage drops are prevented** by this insulation.

A **high mechanical resilience** as well as a low creep and therefore a high durability are provided based on the cross-linked molecule structure of the polyurethane. In addition, DENSOLID®-IPL features a **very good thermal and chemical durability**.

Based on its flexibility, the insulation plate can be used for the insulation of valve foundations as well as for the insulation of pipelines at cable crossings as well as root protection mat.

Typical product properties (Excerpt*)

Property	Unit	Typical value	Test method
Tensile strength	N/mm ²	> 25	DIN EN ISO 527-3
Elongation at break	%	> 600	DIN EN ISO 527-3
Hardness	Shore D	40	DIN ISO 7619-1
Dielectric strength	kV	> 35	-
Volume resistivity	Ω m	3 x 10 ¹¹	DIN IEC 93

* For further product information as well as details on ordering and packaging, please refer to the product data sheet at denso-group.com.

DENSOMIX®

Processing Equipment

DENSOMIX®-400 P

Pneumatic driven dispenser for 2 component cartridges.
For the processing of DENSOLID® cartridges (400 ml).



DENSOMIX®-400 M

Manual dispenser for 2 component cartridges.
For the processing of DENSOLID® cartridges (400 ml).



DENSOMIX®-50

Manual dispenser for 2 component cartridges.
For the processing of DENSOLID®-FK2 C holiday repair coating in 50 ml cartridges.







MarineProtect™

Jetty Pile Protection

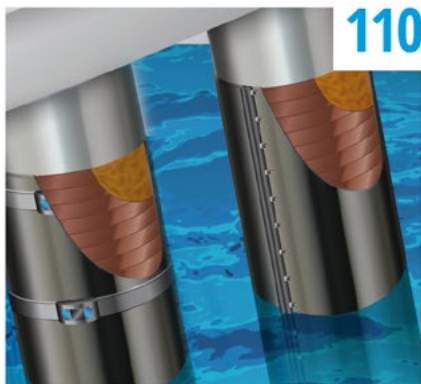

110

MarineProtect™ -Primer/-Tape

The MarineProtect™ systems can be used in many applications and they can easily be applied to piles made from metal, concrete or wood. A special advantage of MarineProtect™ is the easy application above as well as under water. This is also possible for the later protection of already existing systems.



112

MarineProtect™-100

For the MarineProtect™-100 system, the MarineProtect™-Jacket is fastened through an easily executed and reliable tension belt system. MarineProtect™ is very flexibly applicable and permits the protection of adjacent piles with different diameters without large adaptations.

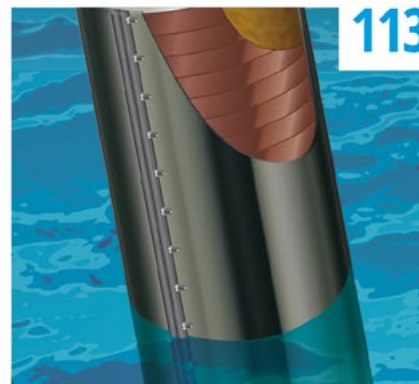

113

MarineProtect™-2000 FD

The MarineProtect™-Jacket in the system MarineProtect™-2000 FD features a weld connected lock bar, which guarantees an easy and reliable installation due to its high quality screw connection. Therefore, MarineProtect™-2000 FD offers a very good prevention against corrosion as well as against wind, tide and breakwater.

MarineProtect™-Primer

Primer mastic for the protection of metal, concrete and wooden piles and underwater pipes.

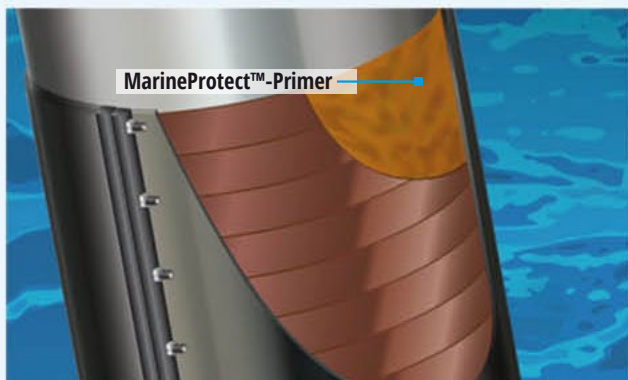

For temperatures from -50°C to +80°C (-58°F to +176°F).



Simple and fast application.



Environmentally safe.



No drying time.



Application under water possible.

MarineProtect™-Primer represents the basic corrosion and weathering prevention in the systems **MarineProtect™-100** and **MarineProtect™-2000 FD** for the corrosion and weather prevention of piles or pipes in water and in the splash water area.

MarineProtect™-Primer is a versatile system that can easily be applied to piles made from **metal, concrete and wood** and pipelines laid under water. The MarineProtect™-Primer is based on a **natural wax** and permits a good moistening of the steel surface even under the water surface. By spreading the primer, the water is displaced from the steel surface and a moisture barrier is created, which prevents a continuation of the steel corrosion.

MarineProtect™-Primer only needs little surface preparation and therefore permits a fast and economic coating. After the application of MarineProtect™-Primer, the surface is prepared for the wrapping with **MarineProtect™-Tape**. Indentations and irregularities can be filled and closed with the MarineProtect™-Primer.

The MarineProtect™-Primer is outstandingly qualified for the coating of new as well as for the rehabilitation of existing constructions.

Typical product properties (Excerpt*)

Property	Unit	Typical value	Test method
Density	g/cm ³	app. 0.90	ISO 2811
Dripping point	°C (°F)	≥+100 (≥+210)	DIN 51801
Area consumption	kg/m ²	app. 0.35	
Operating temperature	°C (°F)	-40 to +70 (-40 to +158)	

* For further product information as well as details on ordering and packaging, please refer to the product data sheet at denso-group.com.

MarineProtect™-Tape

Corrosion prevention tape for the protection of metal, concrete and wooden piles and underwater pipes.

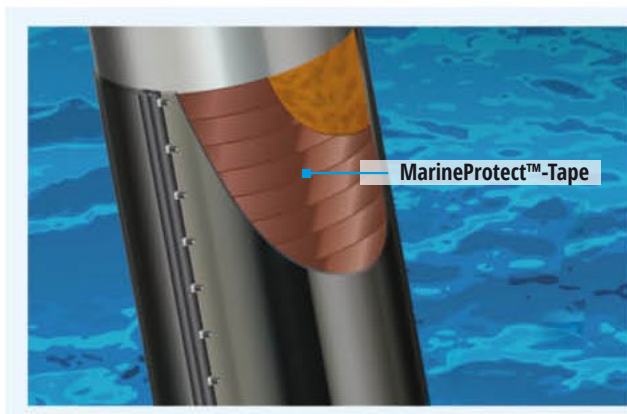

For temperatures from -50°C to +80°C (-58°F to +176°F).



Easy and fast processing.



High flexibility.



Environmentally safe.



No drying time require.



Proven and durable corrosion prevention through a petrolatum tape – an invention by DENSO.

MarineProtect™-Tape represent the essential corrosion prevention in the systems **MarineProtect™-100** and **MarineProtect™-2000 FD**, coating systems for a durable corrosion and weather protection of piles in the water and the splash zone.

MarineProtect™-Tape will be applied to surfaces that were coated beforehand with MarineProtect™-Primer. MarineProtect™-Tape is a versatile system that can easily be applied to piles made from **metal, concrete and wood** and pipelines laid under water.

The development of the MarineProtect™-Tape is based on more than 90 years of experience by DENSO Group Germany with petrolatum tapes. MarineProtect™-Tape consists of a robust polyester nonwoven, which is soaked in a petrolatum mastic.

The MarineProtect™-Tape is very **flexible** and can therefore be applied easily on all surface forms. Matching different pile diameters, MarineProtect™-Tape is available in several roll widths.

The MarineProtect™-Tape is impermeable for corrosive media such as oxygen and water and **resistant against salt water**.

Typical product properties (Excerpt*)

Property	Unit	Typical value	Test method
Total thickness	mm	1.2	
Saponification number	mg /KOH/g	< 10	EN 12068
Dripping point	°C (°F)	≥ +120 (≥ +248)	DIN 51801
Overlapping	%	50	
Operating temperature	°C (°F)	-40 to +70 (-40 to +158)	

* For further product information as well as details on ordering and packaging, please refer to the product data sheet at denso-group.com.

MarineProtect™-100

Protection against corrosion and weather for piles made of metal, concrete or wood and underwater pipes

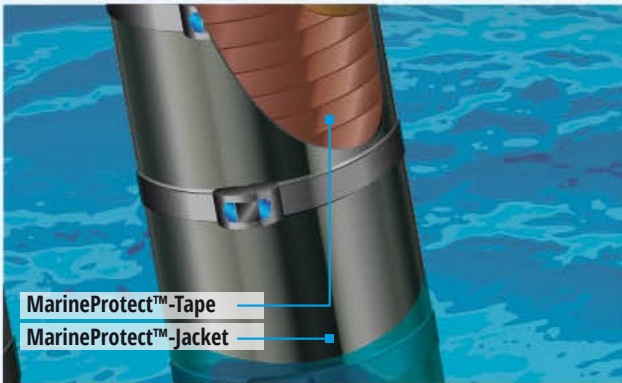

For temperatures from -50°C to +70°C (-58°F to +158°F).



Adapts to different diameters.



No water evacuation required.



Can be applied without interruptions or waiting time.



Consumption can be calculated for maximum cost effectiveness.



Environmentally friendly. Complies with OECD aquatic guidelines 201, 202 and 203.

MarineProtect™-100 is a variable system solution that adapts to the changing dimensions of piles due to the effects of corrosion or erosion, providing protection against corrosion and weather conditions in coastal areas for **piles and pipes** that are fully or partly submerged in water.

The solution is ideal for **use in highly corrosive environments** in which conventional priming and coating systems fail to provide the required level of protection.

MarineProtect™-100 is a flexible system that can be used on **metal, concrete or wooden** piles and underwater pipelines. The solution adapts to suit round or hexagonal piles.

MarineProtect™-100 is easy to apply both on dry land or under water. There is no need for the protected component to undergo a costly drying process or to wait for individual layers to cure, as is generally the case with other coating systems.

This makes the product highly cost effective, with a **controlled application method** that actively helps to **reduce costs**.

The solution is also an economical way to add protection to existing systems without removing previous coatings.

MarineProtect™-100 significantly **extends the service life** of pile constructions and underwater pipelines and reduces the costs involved in their restoration and repair.

To **protect the flora and fauna** living in our seas and lakes, MarineProtect™-100 complies with the OECD aquatic guidelines 201, 202 and 203.

Material consumption:

MarineProtect™ primer:

app. 350 g per m² surface

MarineProtect™ tape:

app. 2 m² per m² surface

MarineProtect™ jacket:

Number of ready-made jackets depends on height of pile to be protected

Product processing:

Please follow the processing recommendations available separately for

MarineProtect™-100.

Typical product properties (Excerpt*)





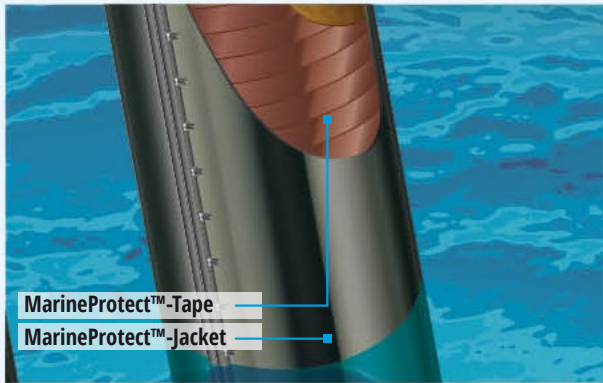

Property	Unit	MarineProtect™ – Typical value	Test method
Primer	Density	app. 0.90	ISO 2811
	Dripping point	≥ +100 (≥ +210)	DIN 51801
Tape	Thickness	1.2	-
	Dripping point	≥ +120 (≥ +248)	DIN 51801
	Saponification number	≤ 10	DIN EN 12068
Jacket	Thickness	app. 2	-
	Elongation at break	≥ 700	ASTM D 638
	Tensile strength	≥ 21	ASTM D 638
System	Impact resistance	≥ 15	DIN EN 12068
	Operating temperature	-40 to +50 (-40 to +122)	-

* For further product information as well as details on ordering and packaging, please refer to the product data sheet at denso-group.com.

MarineProtect™-2000 FD

Protection against corrosion and weather for piles made of metal, concrete or wood and underwater pipes



-  For temperatures from -50°C to +70°C (-58°F to +158°F).
-  Tailored project solution.
-  High mechanical resistance. High resistance to ice.
-  Follow-up checks possible for maintenance purposes.
-  No water evacuation required.
-  Can be applied without interruptions or waiting time.
-  Environmentally friendly. Complies with OECD aquatic guidelines 201, 202 and 203.

MarineProtect™-2000 FD is a ready-made, dimensionally stable system solution for coastal and maritime corrosion and weather protection on **piles or pipes** that are fully or partly submerged in water. The solution is ideal for **use in highly corrosive environments** in which conventional priming and coating systems fail to provide the required level of protection.

MarineProtect™-2000 FD is a flexible solution that delivers **high levels of mechanical resistance**. It is easy to apply to piles of any shape made from **metal, concrete or wood** and to underwater pipelines.

Even in areas that become very icy in winter, the solution continues to provide reliable protection.

MarineProtect™-2000 FD is easy to apply both on dry land or under water. There is no need for the protected component to undergo a costly drying process or to wait for individual layers to cure, as is generally the case with other coating systems.

This makes the product highly cost effective, with a **controlled application method** that actively helps to **reduce costs**.

The solution is also an economical way to add protection to existing systems without removing previous coatings.

The use of MarineProtect™-2000 FD significantly **increases the service life** of pile constructions and underwater pipelines while **reducing repair costs**.

The ability to open and re-seal the jackets for maintenance purposes makes it easy to check the condition of the piles.

To **protect the flora and fauna** living in our seas and lakes, MarineProtect™-2000 FD complies with the OECD aquatic guidelines 201, 202 and 203.

Material consumption:

MarineProtect™ primer:

app. 350 g per m² surface

MarineProtect™ tape:

app. 2 m² per m² surface

MarineProtect™ jacket:

Number of ready-made jackets depends on height of pile to be protected

Product processing:

Please follow the processing recommendations available separately for **MarineProtect™-2000 FD**.

Typical product properties (Excerpt*)

	Property	Unit	MarineProtect™ – Typical value	Test method
Primer	Density	g/cm ³	app. 0.90	ISO 2811
	Dripping point	°C (°F)	≥ +100 (≥ +210)	DIN 51801
Tape	Thickness	mm	1.2	-
	Dripping point	°C (°F)	≥ +120 (≥ +248)	DIN 51801
	Saponification number	mg KOH/g	≤ 10	DIN EN 12068
Jacket	Thickness	mm	app. 2	-
	Elongation at break	%	≥ 700	ASTM D 638
	Tensile strength	N/mm ²	≥ 21	ASTM D 638
System	Impact resistance	J	≥ 15	DIN EN 12068
	Operating temperature	°C (°F)	-40 to +50 (-40 to +122)	-

* For further product information as well as details on ordering and packaging, please refer to the product data sheet at denso-group.com.



DEPROTEC®

Mechanical Protection Systems

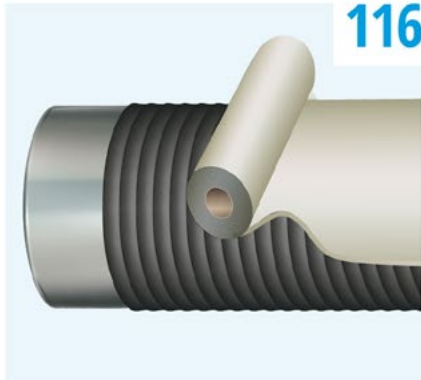

DEPROTEC®-DRM Rockshields

DEPROTEC®-DRM rockshields and protective hoses are applied over corrosion prevention coatings (such as DENSO® or DENSOLEN® tapes) to provide outstanding additional protection against mechanical loads.

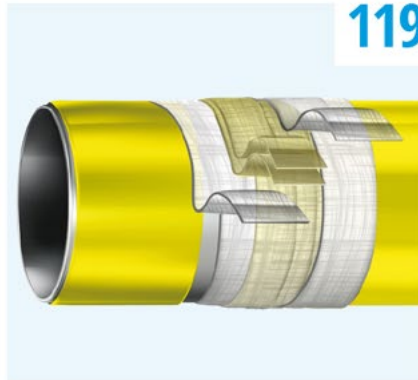

DEPROTEC®-GFK Protective Casing

High mechanical stress-resistant, light-curing GRP protective casing for trenchless pipeline installations, e.g. when laying by pipe driving or pipe ramming.

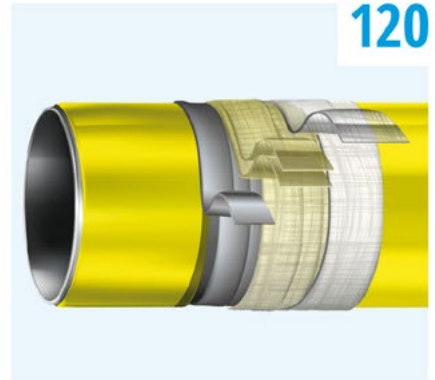

DEPROTEC®-GFK System Corrosion Prevention

Mechanically highly resistant corrosion prevention system for pipelines, consisting of a DENSOLEN® anti-corrosion coating and the DEPROTEC®-GFK protective casing, when laying in trenchless pipeline installations, such as horizontal directional drilling (HDD) or pipe-plough methods.

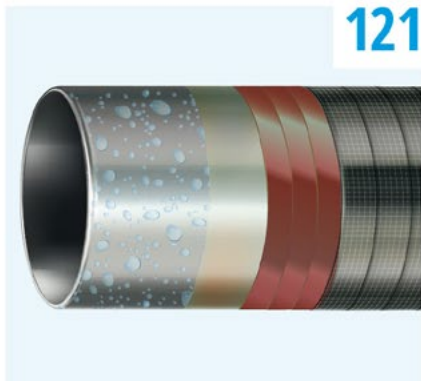

DEPROTEC®-PUR Protection Bandage

Glass fibre bandage for additional mechanical protection of anti-corrosion coatings.

DEPROTEC®-DRM PP 500 Plus

DEPROTEC®-DRM PP 1000 Plus

Non-woven material made from plastic fibres to provide additional mechanical protection for corrosion prevention coatings on steel and cast iron pipelines, plastic pipes and plastic casing pipe connections in district heating systems.

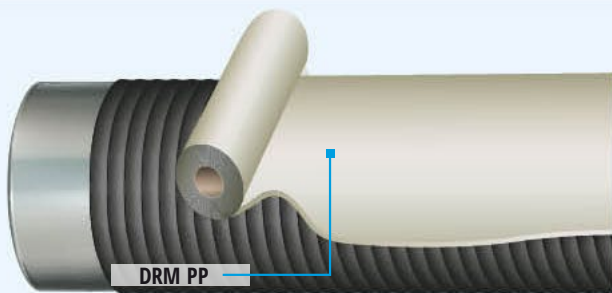

- For temperatures from -50°C to +100°C (-58°F to +212°F).
- High mechanical resistance.
- Easy application.
- Resistant to rotting even in aggressive soils.
- Water and current permeable.
- Shock-absorbing and load-distributing.

DEPROTEC®-DRM PP 500 Plus & 1000 Plus rockshields and hoses are made from a non-woven polypropylene material. They are specially designed to provide additional mechanical protection on field joint and factory coatings.

DEPROTEC®-DRM PP 500 Plus & 1000 Plus **boast high mechanical resistance** and an outstanding ability to **cope with high temperatures**. Good permeability for soil electrolytes guarantees **undisturbed cathodic corrosion prevention** along the pipeline.

DEPROTEC®-DRM PP 500 Plus & 1000 Plus form a reliable separating layer between the pipeline coating and the surrounding earth, ensuring that the load applied to the coating is minimised if the pipeline moves, for example as a result of temperature fluctuations.

DEPROTEC®-DRM PP 500 Plus & 1000 Plus can be used with high thermal loads >+50°C (+122°F).

DEPROTEC®-DRM PP 500 Plus & 1000 Plus rockshields permit the partial or total omission of sand backfilling, depending on the soil conditions. All applicable standards and regulations relating to pipe embedding, trench backfilling and soil compacting must be followed.

Typical product properties (Excerpt*)

Properties	Unit	DEPROTEC®-DRM PP – Typical value		Test method
		500 Plus	1000 Plus	
Weight per unit area	g/m ²	500	1000	EN ISO 9864
Thickness (for an extra load of 2 kPa)	mm	4	7	EN ISO 9863-1
Elongation at break (longitudinal/transverse)	%	70/70	90/90	EN ISO 10319
Tensile strength (longitudinal/transverse)	kN/m	32/32	60/70	EN ISO 10319
Static puncture force (CBR)	kN	5.5	11	EN ISO 12236
Colour	-	white	white	-
Resistant against	-	Diluted acids and lyes, brines, soil bacteria		-
Operating temperature	°C (°F)	-50 to +100 (-58 to +212)		-





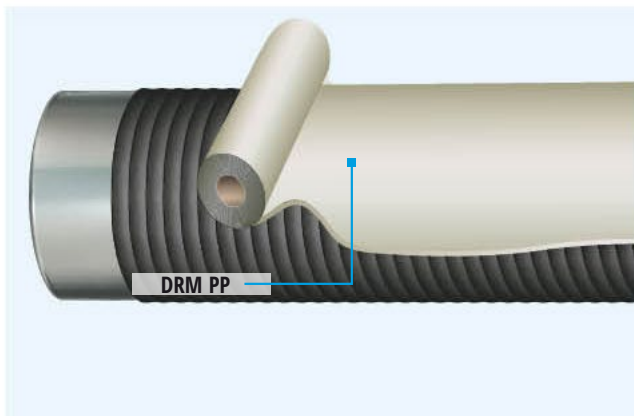

* For further product information as well as details on ordering and packaging, please refer to the product data sheet at denso-group.com.

DEPROTEC®-DRM PP 609

DEPROTEC®-DRM PP 809

Non-woven material made from plastic fibres to provide additional mechanical protection for corrosion prevention coatings on steel and cast iron pipelines, plastic pipes and plastic casing pipe connections in district heating systems.



-  For temperatures from -50°C to +100°C (-58°F to +212°F).
-  Heat resistant.
-  Easy application.
-  Resistant to rotting even in aggressive soils.
-  Water and current permeable.
-  Shock-absorbing and load-distributing.

The **DEPROTEC®-DRM PP609 & 809** rockshields are robust non-woven materials made from PP (809) and PP/PET fibres (609) designed to provide additional mechanical protection for field joint and factory coatings. DEPROTEC®-DRM PP609 & 809 **boast high mechanical resistance** and an outstanding ability to **cope with high temperatures**. Good permeability for soil electrolytes guarantees **undisturbed cathodic corrosion prevention** along the pipeline.

DEPROTEC®-DRM PP609 & 809 form a reliable separating layer between the pipeline coating and the surrounding earth, ensuring that the load applied to the coating is minimised if the pipeline moves, for example as a result of temperature fluctuations.

DEPROTEC®-DRM PP609 & 809 can be used with high thermal loads >+50°C (+122°F).

DEPROTEC®-DRM PP609 & 809 rockshields permit the partial or total omission of sand backfilling, depending on the soil conditions. All applicable standards and regulations relating to pipe embedding, trench backfilling and soil compacting must be followed.

Typical product properties (Excerpt*)

Properties	Unit	DEPROTEC®-DRM PP – Typical value		Test method
		609	809	
Weight per unit area	g/m ²	900	900	EN ISO 9864
Thickness (for an extra load of 2 kPa)	mm	6	6	EN ISO 9863-1
Elongation at break (longitudinal/transverse)	%	87/92	>80	EN ISO 10319
Tensile strength (longitudinal/transverse)	kN/m	20/21	45/35	EN ISO 10319 DIN53.587-2
Static puncture force (CBR)	kN	5	-	EN ISO 12236
Colour	-	white	white	-
Resistant against	-	Diluted acids and lyes, brines, soil bacteria		-
Operating temperature	°C (°F)	-50 to +100 (-58 to +212)		-

* For further product information as well as details on ordering and packaging, please refer to the product data sheet at denso-group.com.

DEPROTEC®-DRM PP 800 Plus

DEPROTEC®-DRM PP 2000 Plus

Non-woven material made from plastic fibres to provide additional mechanical protection for corrosion prevention coatings on steel and cast iron pipelines, plastic pipes and plastic casing pipe connections in district heating systems.

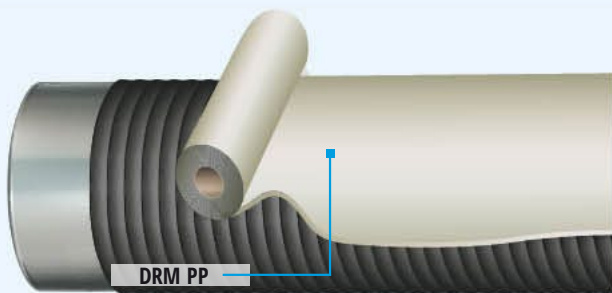

- For temperatures from -50°C to +100°C (-58°F to +212°F).
- High mechanical resistance.
- Easy application.
- Resistant to rotting even in aggressive soils.
- Water and current permeable.
- Shock-absorbing and load-distributing.

DEPROTEC®-DRM PP 800 PLUS & 2000 PLUS rockshields are made from specially designed polypropylene and polyester fibre non-woven materials to provide additional mechanical protection on field joint and factory coatings.

DEPROTEC®-DRM PP 800 PLUS & 2000 PLUS **boast high mechanical resistance** and an outstanding ability to **cope with high temperatures**. Good permeability for soil electrolytes guarantees **undisturbed cathodic corrosion prevention** along the pipeline.

DEPROTEC®-DRM PP 800 PLUS & 2000 PLUS form a reliable separating layer between the pipeline coating and the surrounding earth, ensuring that the load applied to the coating is minimised if the pipeline moves, for example as a result of temperature fluctuations.

DEPROTEC®-DRM PP 800 PLUS & 2000 PLUS can be used at elevated **temperatures of up to +100°C (+212°F)**.

DEPROTEC®-DRM PP 800 PLUS & 2000 PLUS rockshields permit the partial or total omission of sand backfilling, depending on the soil conditions. All applicable standards and regulations relating to pipe embedding, trench backfilling and soil compacting must be followed.

Typical product properties (Excerpt*)





Properties	Unit	DEPROTEC®-DRM PP – Typical value		Test method
		800 Plus	2000 Plus	
Weight per unit area	g/m ²	800 (-10%)	2000 (-10%)	EN ISO 9864
Thickness	mm	6.2 (±20%)	14 (±20%)	EN ISO 9863-1
Elongation at break (longitudinal/transverse)	%	> 50/> 50	> 50/> 50	EN ISO 10319
Tensile strength (longitudinal/transverse)	kN/m	26/34 (-13%)	55/130 (-15%)	EN ISO 10319
Static puncture force (CBR)	kN	5 (-15%)	20 (-20%)	EN ISO 12236
Static puncture force	kN	3.6 (-20%)	10 (-30%)	NF G-38019
Resistant against	-	Diluted acids and lyes, brines, soil bacteria		-
Operating temperature	°C (°F)	-50°C to +100°C (-58°F to +212°F)		-
GdF stress class	-	Class 0	Class TR	-

* For further product information as well as details on ordering and packaging, please refer to the product data sheet at denso-group.com.

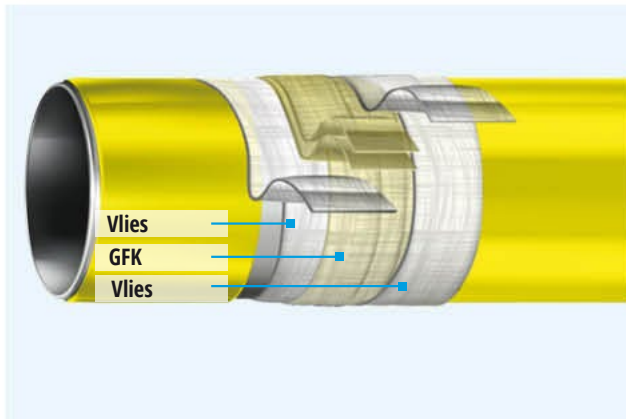
DEPROTEC®-GFK (pipe ramming/driving methods)

Highly mechanical-stress-resistant, light-cured GRP protective coating system



-  For temperatures from -20°C to +80°C (-4°F to +176°F).
-  Abrasion and impact resistant
-  Can be applied manually
-  Single component
-  Cold application

DEPROTEC®-GFK is a protective system for pipeline constructions that are subject to high levels of mechanical stress during installation or operation. The system is made from a high-strength fiberglass composite material. It is typical used for field joint coating of welding seams in trenchless pipeline installations, e.g. using pipe ramming or driving methods, and if the pipeline cannot be bedded in sand.

The applicable standards and guidelines must be followed when bedding and laying pipelines.

DEPROTEC®-GFK is comprised of a single-component light-curing vinyl ester resin, a glass fleece and a fiberglass layer.

Product processing:

Please refer to the separate **DEPROTEC®-GFK** application recommendation.

Typical product properties (Excerpt*)

Properties	Unit	Typical value	Standard
Impact resistance	J/mm	≥ 5 ≥ 10	ISO 21809-3
Indentation resistance (+80°C/+176°F)	%	≤ 1.5	ISO 21809-3
Cathodic disbondment resistance 2d (+60°C/+140°F)	mm	≤ 2.5	ISO 21809-3
Cathodic disbondment resistance 28d (+80°C/+176°F)	mm	≤ 5	ISO 21809-3
Hardness	Shore D	≥ 70	ISO 868
Specific insulation resistance (+23°C/+73°F)	Ωm ²	≥ 2*10 ⁹	ISO 21809-3
Specific insulation resistance (+80°C/+176°F)	Ωm ²	≥ 3*10 ⁸	ISO 21809-3
Shear resistance	N/cm ²	≥ 150	DVGW GW340
Operating temperature	°C (°F)	-10°C to +80°C (-14°F to +176°F)	-

The values listed are based on a **DEPROTEC®-GFK** thickness of ≥ 6,5mm

* For further product information as well as details on ordering and packaging, please refer to the product data sheet at denso-group.com.

DEPROTEC®-GFK System (HDD-Verfahren)

Highly mechanical-stress-resistant corrosion prevention system comprised of a DENSOLEN® corrosion prevention coating and a light-curing GRP protection coating

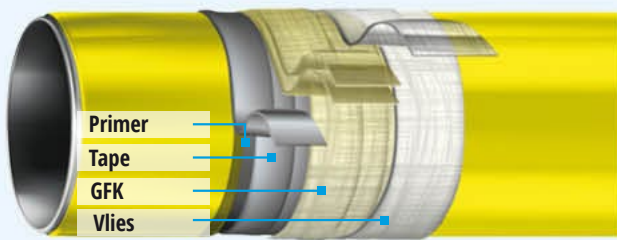

For temperatures from -20°C to +80°C (-4°F to +176°F).



Abrasion and impact resistant



Can be applied manually



Single component



Cold application

The **DEPROTEC®-GFK System** is a corrosion prevention system for pipeline constructions that are subject to high levels of mechanical stress during installation or operation. The system is comprised of a DENSOLEN® corrosion prevention coating and additional mechanical protection provided by a high-strength fibreglass composite material. It's typical used for field joint coating of welding seams in trenchless pipeline installations, e.g. using horizontal directional drilling processes (HDD), and if the pipeline cannot be bedded in sand.

The applicable standards and guidelines must be followed when bedding and laying pipelines.

The **DEPROTEC®-GFK System** is comprised of **DENSOLEN®-HT Primer**, **DENSOLEN®-N60** corrosion prevention tape and a **GFK protective coating** made from a single-component, light-curing vinyl ester resin, a glass fleece and a fibreglass layer.

Product processing:

Please refer to the separate **DEPROTEC®-GFK** application recommendation.

Typical product properties (Excerpt*)

Properties	Unit	Typical value	Standard
Impact resistance	J/mm	≥ 6	ISO 21809-3
		≥ 9	
Indentation resistance (+80°C/+176°F)	%	≤ 1.5	ISO 21809-3
Cathodic disbondment resistance 28d, (+80°C/+176°F)	mm	≤ 9	ISO 21809-3
Hardness	Shore D	≥ 70	ISO 868
Specific insulation resistance (+23°C/+73°F)	Ωm ²	≥ 6.2 · 10 ⁹ (Measuring limit laboratory)	ISO 21809-3
Specific insulation resistance (+80°C/+176°F)	Ωm ²	≥ 6.2 · 10 ⁹ (Measuring limit laboratory)	ISO 21809-3
Shear resistance	N/cm ²	≥ 150	DVGW GW340
Operating temperature	°C (°F)	-10°C to +80°C (-14°F to +176°F)	-

The values listed are based on a **DEPROTEC®-GFK** thickness of ≥ 5,5mm

* For further product information as well as details on ordering and packaging, please refer to the product data sheet at denso-group.com.

DEPROTEC®-PUR

Glass fiber bandage for additional mechanical protection of anti-corrosion coatings.

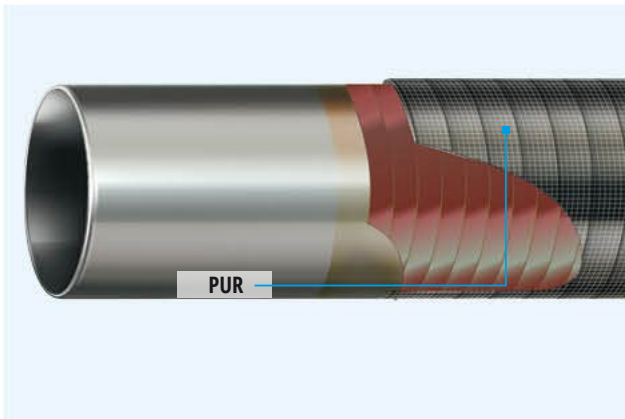

For temperatures from -30°C to +110°C (-22°F to +176°F).



Fast curing within 20 minutes.



Increases mechanical resistance of coatings.



High protection against cutting.



Ready-to-use no laminating necessary.

DEPROTEC®-PUR is a glass fiber bandage for the additional mechanical protection of anti-corrosion coatings and field-joint coating. The glass fiber fabric is soaked in a polyurethane resin and it hardens – depending on the ambient conditions – within approximately 20 minutes to a hard and permanent protective encasement.

DEPROTEC®-PUR can be processed quickly and easily and, based on **its flexibility** during processing, it can also be used **for complex geometries**, e.g. for armatures and flanges. Tools are not required for processing. Extensive and error-prone lamination, as needed for many GRP systems, is not required.

The hardened polyurethane and the resistant glass fibers result in a high mechanical stability at temperatures of up to +110°C (+230°F).

DEPROTEC®-PUR can be used where anti-corrosion coatings are subjected to **strong mechanical stresses**. Therefore, it gives encasements made from DENSO® petrolatum

tapes a significantly higher mechanical resistance. DEPROTEC®-PUR can also be used in combination with DENSOLEN® tapes, e.g. for large area repairs with the DENSOLEN®-Mastic. DEPROTEC®-PUR therefore guarantees an additional stability and prevents an overly cold flow of the butyl mastic.

DEPROTEC®-PUR **increases the impact resistance and the indentation resistance** of field-joint coatings **significantly** and offers a **very good protection against cuttings**.

Typical product properties (Excerpt*)

Reinforcement of DENSOLEN®-AS40Plus	Without DEPROTEC®-PUR	2 layers of DEPROTEC®-PUR	4 layers of DEPROTEC®-PUR	Test method
Impact resistance	15 J	22 J	40 J	DIN EN 12068

Properties	Unit	Typical value	Standard
Operating temperature	°C (°F)	-20°C to +100°C (-4°F to +212°F)	-

* For further product information as well as details on ordering and packaging, please refer to the product data sheet at denso-group.com.



DEXPAND[®]-CF70

System for restoring pipeline integrity based on Carbon Composite materials.

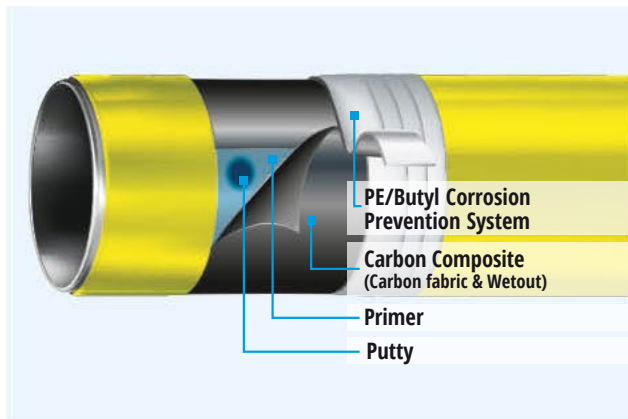

For temperatures from -20°C to +80°C (-4°F to +176°F).



Permanent restoration of the integrity of piping systems.



Rehabilitation in operation — without pipeline interruptions.



Highly cost-effective.



Availability at short notice

DEXPAND[®]-CF70 is a repair system for pipelines with a diameter of ≥ 2 inches (\geq DN 50), and helps to extend the **life expectancy of pipelines**.

After being repaired with DEXPAND[®]-CF70, pipelines that have been damaged by corrosion or erosion regain their **original structural integrity** and can once again be used safely and permanently under **maximum operating pressure**.

DEXPAND[®]-CF70 is also suitable for offshore pipelines thanks to its excellent resistance to salt water.

Repairs can be carried out during ongoing operation and **without time-intensive and cost-intensive pipeline interruptions**.

DEXPAND[®]-CF70 meets the requirements of **ISO /TS 24817 [2006]** and is a suitable **permanent repair method** for the restoration of defects with a minimum residual wall thickness of 20% – regardless of the wall thickness and strength values. The independent laboratories of **TÜV Süd (certificate: IS-AN11-MUC/ml-1915)** have verified the fatigue strength.

The DEXPAND[®]-CF70 **System** comprises the DEXPAND[®]-CF70 **Putty**, the DEXPAND[®]-CF70 **Primer** and a high-strength, mechanical reinforcement consisting of DEXPAND[®]-CF70 **Carbon fabric** and DEXPAND[®]-CF70 **Wetout**.

In order to reduce air pockets during the application process, the DEXPAND[®]-CF70 Compression wrap is temporarily wrapped around the reinforcement while it hardens.

This unique system guarantees that the weakened pipelines receive long-lasting repairs of the highest quality.

The **system structure** in detail:

The DEXPAND[®]-CF70 **Putty** is used to easily even out indentations in the pipe surface. The force is transferred directly to all of the DEXPAND[®]-CF70 components.

The DEXPAND[®]-CF70 **Primer** is a two-component epoxide primer, which enables the transfer of force between the repair system and the pipeline.

The DEXPAND[®]-CF70 **Carbon fabric** is a bidirectional carbon fibre fabric, which absorbs the circumferential forces and axial forces of the pipeline.

Carbon fibres are among the strongest industrially produced fibres. Pipeline repair systems that use carbon fibre technology are currently the most durable non-metallic repair systems.

The DEXPAND[®]-CF70 **Wetout** is a two-component resin. It forms a bond with the layers of mechanical reinforcement. The Wetout ensures that the forces are distributed evenly across the DEXPAND[®]-CF70 system.

The **DENSOLEN[®] Corrosion Prevention Systems** based on PE/butyl rubber round off the system's corrosion prevention features – ensuring reliable pipeline operation for decades.

Typical product properties (Excerpt*)

Property	Unit	Typical value	Test method
Nominal thickness per individual fabric layer	mm	app. 0.55	ISO 21809-3
Percentage of carbon fibres	%	100	
Adhesive strength of DEXPAND[®]-CF70 Primer (+23°C/+80°C) (+73°F/+176°F)	N/mm ²	app. 9.5	EN 10290
Pressure resistance of DEXPAND[®]-CF70 Putty after 24h/ 7d (+60°C/+140°F)	N/mm ²	$\geq 40 / 70$	EN ISO 604
Shore D hardness after 24h/48h (at room temperature)		$\geq 80/84$	ISO 868
Adhesive strength of DENSOLEN [®] -AS39P with HT Primer on DEXPAND [®]	(+23°C/+73°F)	≥ 20	EN 12068
	(+50°C/+122°F)	≥ 3	
Adhesive strength of DENSOLEN [®] -N60 with HT Primer on DEXPAND [®]	(+23°C/+73°F)	≥ 20	EN 12068
	(+50°C/+122°F)	≥ 3	
Operating temperature	°C (°F)	to +70 (to +158)	

* For further product information as well as details on ordering and packaging, please refer to the product data sheet at denso-group.com.



DENSOMAT®

Wrapping Devices

Manual or motor-assisted wrapping devices for the application of SEALID®, DENSOLEN®, DENSIT® and PALIMEX® tapes.



DENSOMAT®-mini

The **DENSOMAT®-mini** is the smallest device in the DENSOMAT® family and ideal for use on pipes with small nominal diameters and where space is limited. The particularly compact design allows for use from nominal pipe sizes of DN 40 (1½ in).

Advantages:

- Ideal for small nominal pipe sizes.
- Ideal where space is limited.



DENSOMAT®-1

The **DENSOMAT®-1** is an all-purpose winding device which covers most areas of application. It can be used from nominal pipe sizes of DN 80 (2 in) on straight pipe sections and on pipe bends from DN 100 (4 in).

Advantages:

- Universal application.
- High sturdiness and long service life.



DENSOMAT®-KGR Junior

The **DENSOMAT®-KGR Junior** allows the application of longer roll lengths. It is perfectly suited to the requirements of larger nominal pipe sizes. With the additional accessories available, it can wrap pipes with nominal diameters of DN 2000 (80 in) and more. The **DENSOMAT®-KGR Junior RT150** is a version with support for rolls with 41 mm cores.

Advantages:

- Fast application even with large nominal pipe sizes.
- Roll diameter up to 350 mm.
- Wide range of accessories.



DENSOMAT®-11

The **DENSOMAT®-11** combines decades of wrapping experience with great flexibility. With an electric or combustion engine, robust and powerful, it is ideal for joint wrapping of large pipe diameters, as well as wrapping whole pipes and rehabilitation of major pipeline sections.

Advantages:

- Maximum efficiency.
- Fastest application.
- Continuous wrapping quality.
- Proven project deployment.

Typical Product Properties (Excerpt*)

	Roll core (mm)	Tape width (mm)	Roll diameter (mm)	Nominal pipe sizes		Minimum working height (cm)	Accessories
				DN	(Inch)		
DENSOMAT®-mini	41	max. 100	max. 100	≥ DN 40	≥ 1,5"	20	Drum rolls
DENSOMAT®-1	41	max. 100	max. 160	≥ DN 80 (pipe elbow ≥ DN 100)	≥ 3"	40	Drum rolls
DENSOMAT®-KGR Junior RT150	41	max. 150	max. 350	≥ DN 200	≥ 8"	40	Drum rolls, extension arm, cage (closed crown)
DENSOMAT®-KGR Junior	78	max. 150	max. 350	≥ DN 200	≥ 8"	40	Drum rolls, extension arm, cage (closed crown)
DENSOMAT®-11	78	max. 100	max. 350	≥ DN 200	≥ 8"	45	-

* For further product information as well as details on ordering and packaging, please refer to the product data sheet at denso-group.com.

ADVANCED IN SEALING.



History

A story of success

Over the past century, DENSO Group Germany has built a reputation founded on experience, quality and reliability in corrosion prevention and innovative sealing technology. Just a few years after the company was founded in 1922 in Berlin, DENSO Group Germany revolutionised passive corrosion prevention across the

Redefining corrosion prevention

14.07.1927: "Schade's plastic protective tape" is patented and goes down in history as the fledgling company's first invention. The "DENSO Tape" (Petrolatum Tape) is the world's first reliable passive corrosion prevention solution for pipes and pipelines and over the coming decades, the name becomes a generic synonym for all types of corrosion prevention tapes.

TOK®-Band: A flexible and stable channel solution

1952: TOK®-Band – a ready-made malleable tape solution for channel sealing – is invented. Up until this point, the only sealing methods available used hot casting or filler. However, these solutions produced a seal that was too rigid, leading to the seal breaking whenever the pipe moved in the ground.

1922



Rising in the midst of collapse

14.11.1922: The company is founded in Berlin under the name Chemieprodukte GmbH. Against the backdrop of a post-war 1920s Germany that is suffering from famine, hyperinflation and unemployment, the company lays the foundations for its future "Made in Germany" story of success.

1927



A name for success

1927: The "DENSO" name is registered. The name comes from the Latin word "densus", which means "to seal".

1946



From the Spree to the Rhine

1946: After the destruction of the company's original premises during the Second World War, the company reforms in Leverkusen. The proximity of the new site to BAYER AG and the Rhine river provides the inspiration for new inventions – and an efficient transport route.



1952



1973



DENSOLEN®: Preserving value with three-ply tape

1973: DENSO Group Germany invents the world's first co-extruded three-ply tape for welding connections on pipes and pipelines. A brand new cold-application technology is used to fuse the layers of the tape together, creating a hose-type permanent seal.



world with DENSO Tape (Petrolatum-Tape), its very first invention. When the company premises were destroyed during the Second World War, the firm relocated its headquarters to a new site on the banks of the Rhine river. The company did not let this setback damage its inventive and entrepreneurial spirit, as testi-

fied by the countless corrosion prevention and sealing technology innovations it rolled out over the following years. Today, DENSO Group Germany is a global group of companies that, in spite of its international reach, still strives to deliver sustainable custom solutions and provide personal service to its customers.

TOK®-Band: Taking quality to the roads

1977: The world's first bitumen joint tape for joints and seams in asphalt road construction is invented. The TOK®-Band name quickly becomes a synonym for all bitumen joint tapes.

1977



2006



TOK®-Sil Resist:

A new product for new partners

2014: The world's first joint sealant for biogas plants and liquid manure, slurry and silage effluent plants provides an effective, permanent seal at the critical point – the intersection between horizontal and vertical joints. The invention of TOK®-Sil Resist is of particular interest to operators of biogas plants.

2014



2021



**SEALID® All-in-1:
The new simplicity in pipeline construction**

2021: The world's innovation offers corrosive and mechanical protection for the first time in only one work step, without primer or devices. SEALID® is universally applicable for pipelines, welded seams, pipe bends or T-pieces.

2021



**DEKOTEC®:
Rapid application – permanent seal**

2006: DEKOTEC® heat shrinkable sleeves featuring innovative hot-melt and mastic technology are launched. The product line is known for its outstanding quality and simple, fast application.

**High temperature products:
Ready for the greatest challenges**

2021: New standards with new tapes and shrink sleeves for extreme temperatures up to +100°C (+212°F).

DENSO ONLINE

You are not yet sure which product is ideal for your requirements? Find it quickly with our extended product finder on denso-group.com !

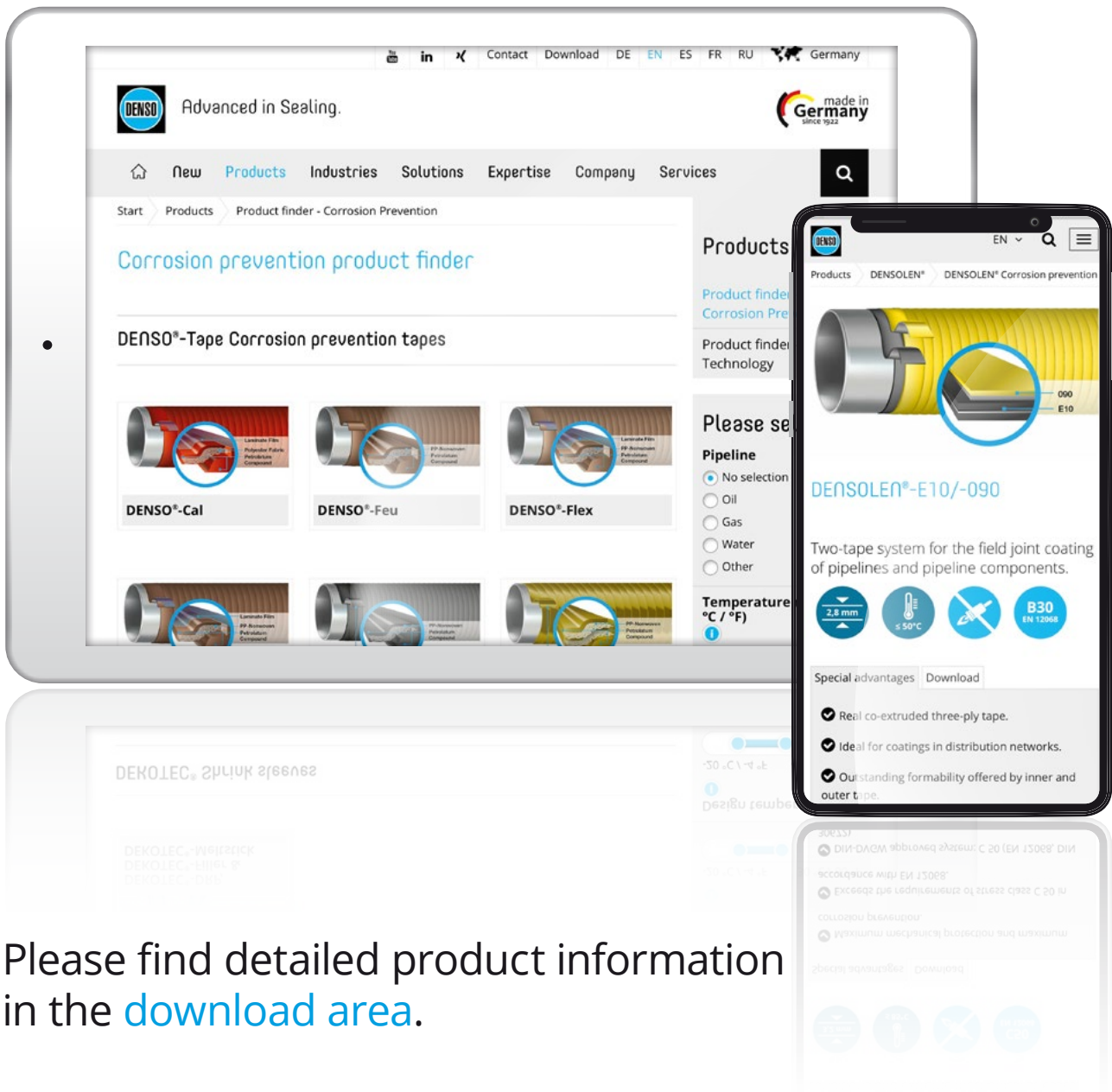

Please find detailed product information in the [download area](#).

ROAD CONSTRUCTION

Get to know our products for road construction online at denso-group.com or in the brochure “Sealing Technology – Road Construction and Maintenance”.



Joints & Seams in Asphalt and Concrete

- Bitumen Joint Tapes
- Joint Seam Adhesive
- Asphalt Reinforcement
- Hot/Cold Pouring Compounds
- Asphalt/Concrete Repair



Joints for High Loads

- Compression Seals
- Sealing Profiles
- Bitumen Joint Tapes
- Stable Joint Compound
- Elastic Mortars



Rail Protection

- Rail Pouring Compound
- Rail Joints Pouring



Find us here:

DENSO GmbH

Felderstraße 24
51371 Leverkusen / Germany
Phone +49 214 2602-0

DENSO Dichtungstechnik

Franzensthalstraße 27 GmbH & Co. KG
2435 Ebergassing / Austria
Phone +43 2234 750

DEKOTEC GmbH

Felderstraße 24
51371 Leverkusen / Germany
Phone +49 214 2602-0 / dekotec.com

DENSO QUIMICA S.A.U.

Apdo. Correos 18 Yunque, 9-11 Nave 12A
28760 Tres Cantos (Madrid) / Spain
Phone +34 91 8064254

DENSOKOR AG

Bahnhofstrasse 36
5502 Hunzenschwil / Switzerland
Phone +41 43 3662244

Imbema DENSO B.V.

Mauritsstraat 5-7 Postbus 160
2000 AD Haarlem / The Netherlands
Phone +31 23 5172424

DENSO France S.A.R.L.

43/45, Rue Jean Jaurés
92300 Levallois-Perret / France
Phone +33 1 41400088

Imbema DENSO N.V./S.A.

Industrieweg 25
9420 Erpe-Mere / Belgium
Phone +32 53805172

denso-group.com

info@denso-group.com

DENSO GmbH

Felderstraße 24 | 51371 Leverkusen | Germany
Phone: +49 214 2602-0 | info@denso-group.com
www.denso-group.com

Our product information, application recommendations and other printed publications provide advice to the best of our knowledge and indicate our level of knowledge at the time of printing. The content is not legally binding. Therefore, no liability is assumed for incorrect and missing advice. The applicator is obliged to check the suitability and possibility of application for the intended purpose. Unless otherwise specified, all of the brands named are trademarks of DENSO, at least registered in Germany, which are

protected by law. Only our general terms and conditions of sale, which you will find at www.denso-group.com, apply. This is a translation from the original German product information. In case of any discrepancy or any dispute arising on the interpretation, the German text of the respective German product information, which is available at www.denso-group.com, shall be decisive. The legal relationship shall be governed by German law. 01.2022